

Radiation Protection Products

KIRAN
A Division of TRIVITRON Healthcare



Trust is what we deliver!

www.kiranxray.com

About Triviron Healthcare

By combining innovation with affordability and accessibility, we are a leading health technology enterprise that has been operating for more than two decades to improve health and medical care throughout the world, like no one else. We consider quality healthcare a fundamental right of people and envisage to make top-notch, cutting edge healthcare technology available for people of all classes.

We lay great emphasis on research and development. Our team includes internationally acclaimed experts and leading scientists who innovate unprecedented health technologies suitable for healthcare needs of today and tomorrow.

We provide technological advancements to hospitals, individual healthcare providers, independent clinics, extended care facilities and laboratories, catering to healthcare needs in multiple verticals like In-Vitro Diagnostics (IVD), Imaging & Radiology (In-vivo Diagnostics), Critical Care & OT Solutions, Newborn screening (NBS) and Radiation Protection Products.

Through a growing network of 1500+ employees, 1200+ channel partners and 15 world-class manufacturing units spread throughout the world, Triviron Healthcare is reaffirming its commitment to offer superior health technologies in 180+ countries saving lives and improving care.

By simplifying and expanding our business, we are rapidly moving to establish ourselves as a global leader in health technology. We are committed to build a sustainable business that delivers value by offering best available health technology solutions for millions of people worldwide.

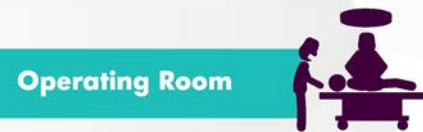

15 Manufacturing and R&D Facilities in India, Finland, USA & Turkey



100+ Years of Combined Manufacturing Experience



Presence in 180 Countries



Kiran & You!

A Story of Mutual Trust & Confidence

Kiran is one of the most respected global brands in the field of Radiology.

The Kiran Journey started in 1974 with our first set of customers who placed their complete trust and confidence in our Radiology products. At Kiran, we have continued to evolve and innovate with the hope of bringing the best technology to our valued customers. Over the past 4 decades, Kiran has become one of the leading solution providers in Medical Imaging, catering to customers in 180 countries across the world.



Kiran is driven by 3 Cardinal Business Principles

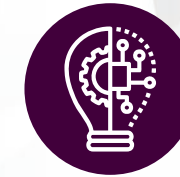

Innovation



Quality



Customer Service

Modalities of Focus



Radiation Protection

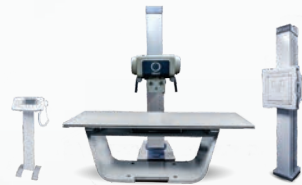

Fixed Radiography



Mobile Radiography



Surgical C-Arm



Mammography



Ultrasound



Contrast Media



Imaging Accessories & Consumables

Kiran - committed to the field of Radiology catering to customers across 180 Countries



Manufacturing Facilities in Mumbai & Pune - India



The Journey So Far

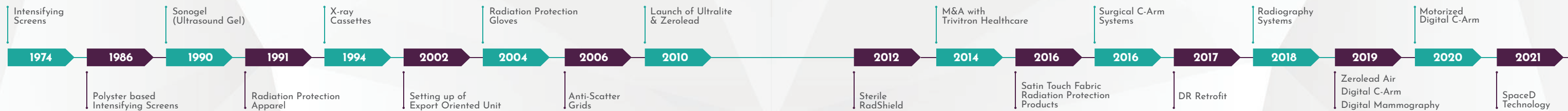

World-Class Radiation Protection Products

Adequate Protection against scatter radiation is of paramount importance for health care professionals working with Radiography, CT, Mammography, C-Arm and Cathlab Systems.

Exposure to a very high dose of radiation over a short period of time can produce acute effects such as redness of skin, hair loss, radiation burns, or even acute radiation syndrome. These are known as the Deterministic Effects of radiation exposure.

Exposure to low dose scatter radiation over an extended period of time may lead to a significant risk of long-term effects such as cancer, which may appear years or even decades later. These are known as the Stochastic Effects of radiation exposure.

It is important to protect medical professionals against the stochastic effects of radiation exposure. Because the effects of exposure is not immediately apparent, it is often ignored and procedures are performed every single day all across the world without optimum protection. The scatter radiation stealthily acts as a silent killer.

Kiran's offerings in radiation protection are the result of relentless R&D to offer you maximum protection & Comfort with adherence to Global Quality Standards and flexibility to customize the apron based on your requirements.

Aprons | Shields | Gloves | Eyewear | Storage Systems | RadShield



Saving the Saviours!

Constant innovation in material science has helped Kiran develop some of the world's finest Radiation Protection products that offer the highest level of radiation attenuation are lightweight, ergonomic and aesthetically appealing.

Kiran offers a wide range of radiation protection products for Interventional Radiology, Cardiology procedures, CT procedures, Image Guided Surgery and General Radiology.

Protection

Kiran's Radiation Protection products are a result of extensive R&D, innovation and are made with world-class core materials which offer maximum radiation attenuation that protects the healthcare providers from the damaging effects of ionizing radiation generated by X-ray systems, C-Arm systems, Cathlabs, Fluoroscopy Systems and CT.

Comfort

Kiran's Radiation Protection products are ergonomically designed with the needs of surgeons, doctors and technicians in mind. Our aprons are lightweight and are offered in a wide range of designs that suits various clinical applications. Every aspect of the apparel is designed for comfort with Lightweight core material, Satin Touch Fabric, shoulder pads, belts etc ensure maximum comfort throughout the procedure and results in reduced fatigue to the Care providers.

Elegance

Kiran's Radiation Protection products offer flexibility to customize the Radiation Protection Products based on your personal preferences and comfort requirements.

We offer a vast range of customization possibilities which allows you to get Kiran apron created exactly the way you want it.

Wide Range of Customization Options



Colors

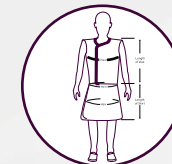

Sizes



Name Tag



Embroidery



Belts



Closures

KIRAN^{*}

Functionality
&
Fashion



Contents

Page No

Certifications

10 -11

Core Materials

12 -15

Aprons - Weight Chart

16 -17

Satin Touch Fabric

18 -19

Maxin Fabric

20 -21

SpaceD Technology

22 -23

Radiation Protection Aprons

24 - 47

Protective Shields

48 -53

Protective Accessories

54 - 73

Radiation Protection Gloves

74 -79

Eye Protection

80 -85

Measurement

86 -87

Article Code Guide

88 - 95

Compliance to International Quality Standards

Our quality systems are assessed and certified as per the guidelines of ISO 9001:2015 and ISO 13485:2016.

Our Products conform to the stringent quality norms of CE, as specified by European Council's Medical Device Directive (MDD) contained in 93 / 42 / EEC, as well as Regulation(MDD) 2017/745 & also PPE Regulation (EU) 2016/425 NB no 0598.

Most of our Radiation Protection Products meet or exceed EN 61331-1:2014, EN 61331-1:2014, IEC 61331-1:2014, ASTM 2547, EN 388:2016, EN 420:2003+A1:2009, DIN & IS Standards. Our manufacturing facilities are registered with USFDA.



Health
Canada



DIN EN
Deutsches Institut für Normung

ICMED

Kiran has been registered by Intertek as conforming to the requirements of ICMED 13485 (Indian Certification for Medical Devices Certification Scheme)



R&D Facility

Kiran has its own R&D facility, approved by Department of Scientific and Industrial Research (DSIR), measuring 100 m² of Area.



Our Testing Facilities

Kiran has its own state-of-the-art Radiographic Testing Centre where we test our products during research and development as well as in-process quality control and final testing before release for sale.



The Secret Ingredients

World-Class Core materials have been the cardinal components of Kiran's Radiation Protection Products. The core materials are made possible through extensive research in particle engineering and cutting edge material science and offer maximum protection from ionizing radiation.

Wide Range of Core Materials

- Maximum protection against scattered radiation—a key health consideration
- Protection for the upper body and the sensitive thyroid gland at a lead equivalence of 0.50 mm Pb & 1.00 mm Pb
- Basic back protection required for use in CT Scans and Cath labs at a lead equivalence of 0.25 mm Pb
- Solutions for the varying needs of X-ray technicians, medical professionals, and patients

ZeroLead^{AIR}™

The World's Finest

 10% Lighter than Zerolead	 Micro Particle Bismuth & Antimony	 Ecofriendly Material
 Odour-Free Plasticizers	 Lesser Fatigue	 Ultimate Comfort
 Micro Particle Technology for better protection from scatter radiation		

ZeroLead[®]

An Eco-friendly Technological Breakthrough

 Extremely Light	 Bismuth & Antimony particles	 Ecofriendly Material
 Odour-Free Plasticizers	 Resistant to Humidity	 Lesser Fatigue
 Stability between -20° to +70° Centigrade		

ultralite™

An Optimized Weight Sheeting

 Lighter than Leadlite	 Antimony & Lead particles	 Optimum Safety
 Odour-Free Plasticizers	 Resistant to Humidity	 Ergonomic Comfort
 Stability between -20° to +70° Centigrade		

LEADLITE[®]

The Industry Standard Re-defined

 Lightest Lead Material	 Purest & Finest Lead Particles	 Use of minimum Bonding & Mineral oils
 Odour-Free Plasticizers	 Resistant to Humidity	 Materials remain supple for several years
 Stability between -20° to +70° Centigrade		

Radiation Attenuation Data



% Attenuation

Protection at Various Voltages		0.25 mm	0.35 mm	0.50 mm	1.00 mm
ZeroLead AIR	Radiation Energy Beam Level				
	60 kV	97 %	99 %	100 %	≥100 %
	70 kV	94 %	98 %	99 %	100 %
	80 kV	91 %	96 %	98 %	100 %
	90 kV	88 %	94 %	96 %	99 %
	100 kV	85 %	92 %	95 %	99 %
	110 kV	82 %	90 %	93 %	99 %
	120 kV	80 %	88 %	92 %	98 %
130 kV	78 %	86 %	91 %	97 %	

% Attenuation

Protection at Various Voltages		0.25 mm	0.35 mm	0.50 mm	1.00 mm
ZeroLead	Radiation Energy Beam Level				
	60 kV	97 %	99 %	100 %	≥100 %
	70 kV	94 %	98 %	99 %	100 %
	80 kV	91 %	96 %	98 %	100 %
	90 kV	88 %	94 %	96 %	99 %
	100 kV	85 %	92 %	95 %	99 %
	110 kV	82 %	90 %	93 %	99 %
	120 kV	80 %	88 %	92 %	98 %
130 kV	78 %	86 %	91 %	97 %	

*Uncertainty of Measurement: ±7 %

Radiation Attenuation Data

Kiran's Products offers maximum Radiation Attenuation at broad-beam conditions according to ASTM 2547-18. The Lead Equivalence is determined using narrow as well as inverse broad-beam geometry according to EN 61331-1:2014 & EN 61331-3 : 2014 for the specified range - 50kV to 150kV

% Attenuation

Protection at Various Voltages		0.25 mm	0.35 mm	0.50 mm	1.00 mm
ultralite	Radiation Energy Beam Level				
	60 kV	97 %	99 %	100 %	≥100 %
	70 kV	94 %	98 %	99 %	100 %
	80 kV	91 %	96 %	98 %	100 %
	90 kV	88 %	93 %	96 %	99 %
	100 kV	85 %	91 %	95 %	99 %
	110 kV	83 %	90 %	94 %	99 %
	120 kV	81 %	88 %	93 %	98 %
130 kV	79 %	86 %	91 %	99 %	

% Attenuation

Protection at Various Voltages		0.25 mm	0.30 mm	0.35 mm	0.50 mm	1.00 mm
LEADLITE	Radiation Energy Beam Level					
	60 kV	97 %	98 %	99 %	100 %	≥100 %
	70 kV	95 %	97 %	98 %	99 %	100 %
	80 kV	92 %	94 %	96 %	97 %	100 %
	90 kV	88 %	92 %	94 %	96 %	99 %
	100 kV	86 %	90 %	92 %	95 %	99 %
	110 kV	85 %	88 %	91 %	94 %	99 %
	120 kV	84 %	87 %	91 %	94 %	99 %
130 kV	82 %	87 %	90 %	93 %	99 %	

Aprons - Weight Chart



Double-Sided Apron - Maxima

Size/Type	LE, mm Pb		Dimensions cm		Weight of Articles (kg)			
	Front	Back	W/G	L	ZeroLead AIR	ZeroLead	ultralite	LEADLITE
L	0.5	0.25	60	100	5.87	6.52	6.73	7.16

Double-Sided Apron - Optima

Size/Type	LE, mm Pb		Dimensions cm		Weight of Articles (kg)			
	Front	Back	W/G	L	ZeroLead AIR	ZeroLead	ultralite	LEADLITE
L	0.5	0.25	60	100	5.69	6.32	6.61	7.06

Vest - Maxima

Size/Type	LE, mm Pb		Dimensions cm		Weight of Articles (kg)			
	Front	Back	W/G	L	ZeroLead AIR	ZeroLead	ultralite	LEADLITE
L	0.5	0.25	60	63	3.60	4.00	4.20	4.40



Skirt - Maxima/Optima

Size/Type	LE, mm Pb		Dimensions cm		Weight of Articles (kg)			
	Front	Back	W/G	L	ZeroLead AIR	ZeroLead	ultralite	LEADLITE
L	0.5	0.25	192	57	3.17	3.52	3.66	3.86

Coat Apron

Size/Type	LE, mm Pb		Dimensions cm		Weight of Articles (kg)			
	Front	Back	W/G	L	ZeroLead AIR	ZeroLead	ultralite	LEADLITE
L	0.5	-	60	100	3.35	3.70	4.10	4.20

Coat Apron with Attached Thyroid Collar

Size/Type	LE, mm Pb		Dimensions cm		Weight of Articles (kg)			
	Front	Back	W/G	L	ZeroLead AIR	ZeroLead	ultralite	LEADLITE
L	0.5	-	60	100	4.14	4.50	4.90	5.20

Satin touch

Smooth • Comfortable • Hygienic

Satin Touch includes a range of fabric that are infused with silver nanoparticles which impart antimicrobial properties to the fabric thereby preventing microbial growth. This advanced material provides all the benefits, while offering a super smooth satin feel, making it extremely comfortable to wear over long durations.

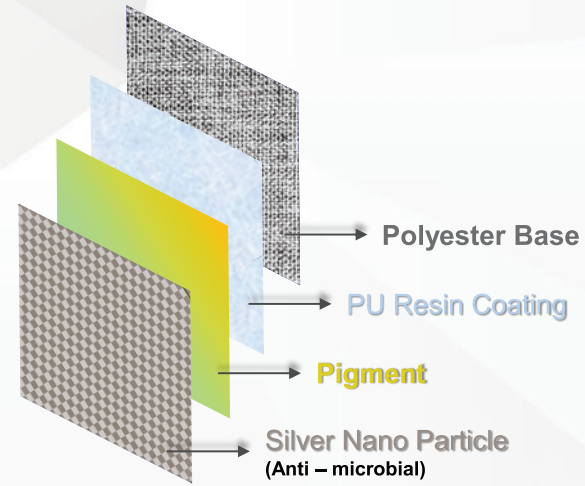

Wide Range of Color Options



Standard Color Combinations



*Additional color combinations available upon request

Maxin Fabric

EXPERIENCE
THE LIGHTEST

RADIATION PROTECTION APPAREL



Water Repellent



Superior Insulation



**Absorption +
Moisture Control**



Polyester Base



Protective Knit



"Maxin" Fabric which includes range of fabric that is Versatile & lightweight enhanced by PU coating for higher resistance to UV. Increased with stronger strength, and pliability which impart antimicrobial properties to the fabric thereby preventing microbial growth. This advanced material provides all the benefit to the user, while offering Ultra Durable & Feather Soft feel, making it extremely comfortable to wear over long durations.

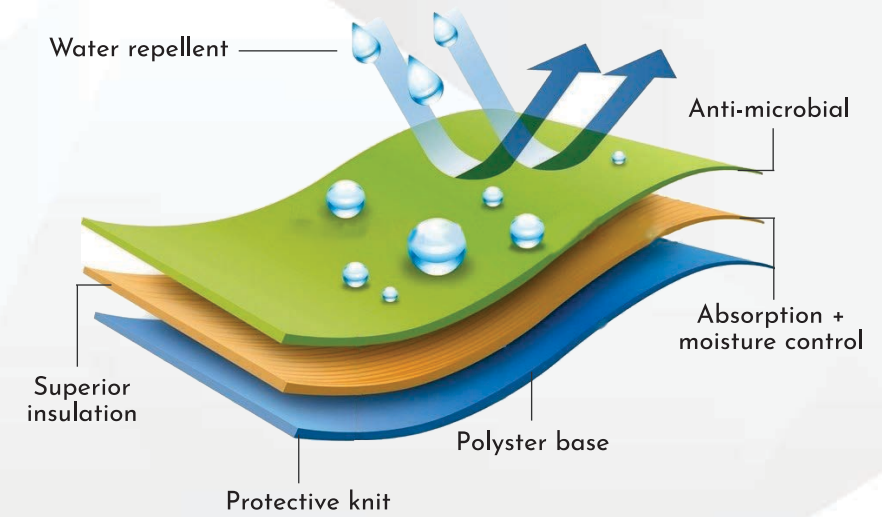

Wide Range of Color Options:



Azure Blue

Graphite Grey

Ocean Green

Cosmic Blue





SPACEED

CERTIFIED SPACE TECH APRON

Space Technology now for
Medical Professionals

The Zenith of Radiation Protection



-  Absorbs, stores & releases heat for optimal thermal comfort
-  Helps maintain a comfortable, balanced body temperature
-  Absorbs excess body heat to prevent sweating
-  Anti-microbial with silver nano particles

How SpaceD Technology Works

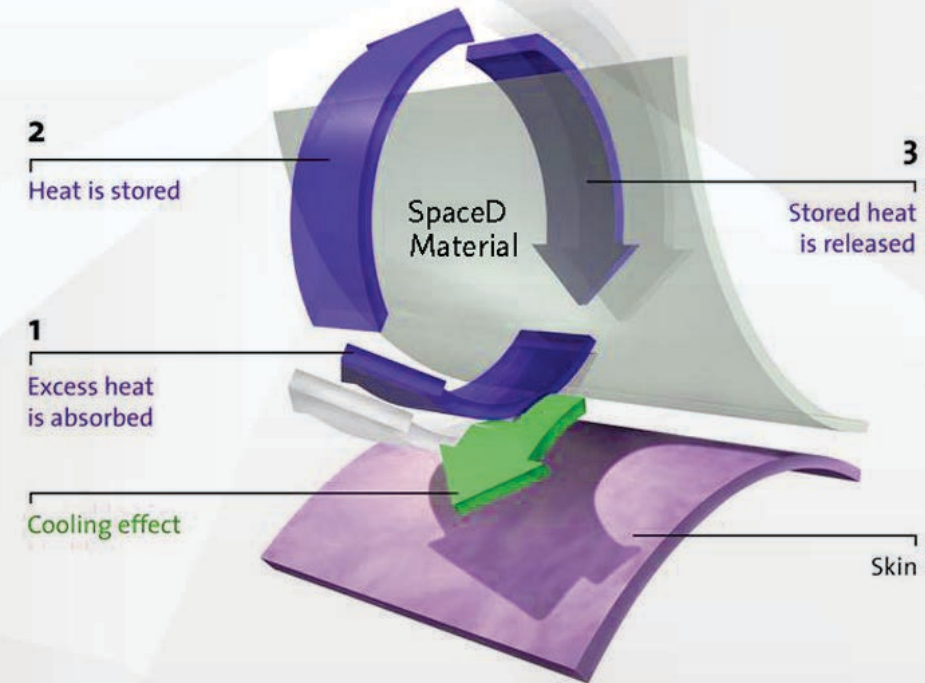

One of Kiran's most unique offering is its temperature regulating inner fabric with SpaceD technology is the only phase change material that carries the Certified Space Technology seal of approval. SpaceD fabric keeps the temperature at optimal levels with not too hot...not too cold....**Just Right.**



RADIATION PROTECTION APRONS

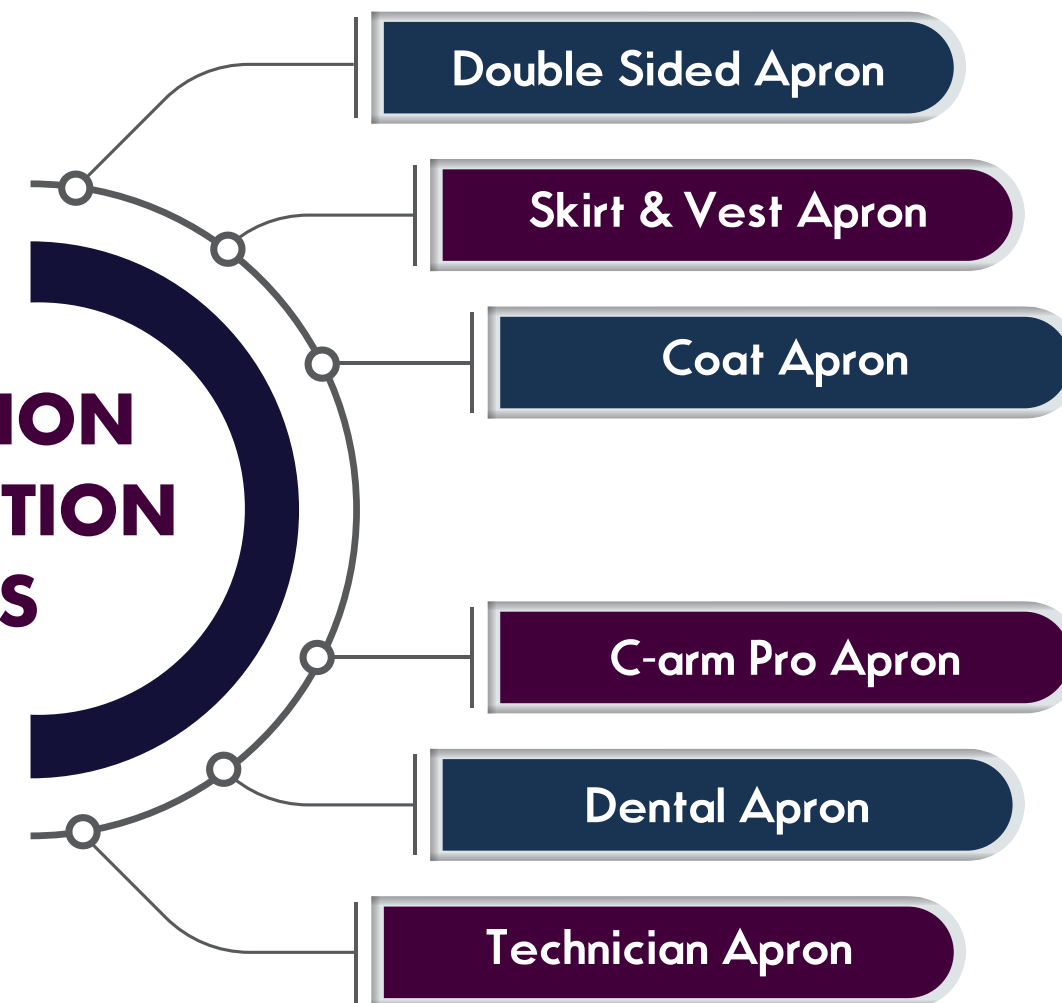

Double Sided Apron - Optima

Loop for attaching Thyroid Shield

Anti-skid Padded Shoulder
(For comfort and weight distribution)

Frontal overlap of 15 cm

Side slit for better mobility



Velcro Panels for Improved fit

Snap Lock for Comfortable fit

Protection Area

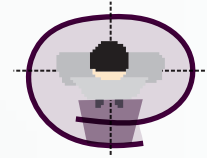

- Fabric Type -

Satin touch
Smooth • Comfortable • Hygienic

Maxin Fabric

SPACEED
CERTIFIED SPACE TECH APRON

Ideal For

1. Cathlabs
2. Interventional Surgical Procedures
 - Interventional Radiology
 - Interventional Cardiology
 - Interventional Urology

Lead Equivalence

Front Protection

Back Protection

0.50 mm Pb

0.35 mm Pb

0.25 mm Pb

Customization Options

Accessories



Extra Belt outside
(to reduce Back & Shoulder stress)



Name Tag



Embroidery
(in Pockets)



Thyroid Shield

Double Sided Apron - Maxima

Anti-skid Shoulder Pads to reduce stress & for equal weight distribution

Pockets Included

Complete frontal overlap for added protection against scattered radiation



Protection Area

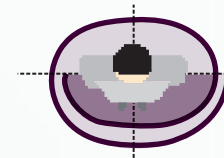

Wide Belt Provided – 4 inch or 6 inch supportive belt keep the garment's weight off the shoulder and hip while providing lumbar support.

- Fabric Type -

Satin touch

Smooth • Comfortable • Hygienic

Maxin Fabric

SPACEED

CERTIFIED SPACE TECH APRON

Ideal For

1. Cathlabs
2. Interventional Surgical Procedures
 - Interventional Radiology
 - Interventional Cardiology
 - Interventional Urology

Snap Lock for Comfortable fit

Lead Equivalence

Front Protection

Back Protection

0.50 mm Pb

0.35 mm Pb

0.25 mm Pb

Customization Options



Name Tag



Embroidery (in Pockets)



Thyroid Shield (Attachable Loop)

Accessories

Skirt & Vest - Optima



Anti-skid Shoulder Pads to reduce stress & for equal weight distribution

Pockets Included

Vest Closure with 3 Velcros (2 inch each) for comfortable fit

Vest overlaps skirt for upto 15 cm which provides additional lower body protection



Adjustable Velcro panels for Comfortable Fit

Snap Lock for proper fit

Protection Area

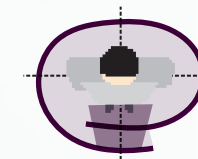

- Fabric Type -

Satin touch
Smooth • Comfortable • Hygienic

Maxin Fabric

SPACEED
CERTIFIED SPACE TECH APRON

Ideal For

1. Cathlabs
2. Interventional Surgical Procedures
 - Interventional Radiology
 - Interventional Cardiology
 - Interventional Urology

Lead Equivalence

Front Protection

Back Protection

0.50 mm Pb

0.35 mm Pb

0.25 mm Pb

Customization Options



Name Tag



Embroidery (in Pockets)



Thyroid Shield (Attachable Loop)

Accessories

Skirt & Vest - Maxima



4 inch Velcro closure for a Snug Fit



Snap lock for proper fixation

Anti-skid Shoulder Pads to reduce stress & for equal weight distribution

Pockets Included

Front Opening for ease of wearing



Vest Overlaps the skirt for sufficient length to ensure protection during movements like Bending forward

Skirt Design for Free Movement

Protection Area

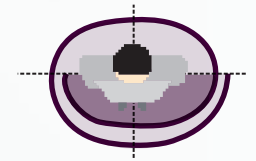

- Fabric Type -

Satin touch
Smooth • Comfortable • Hygienic

Maxin Fabric

SPACEED
CERTIFIED SPACE TECH APRON

Ideal For

1. Cathlabs
2. Interventional Surgical Procedures
 - Interventional Radiology
 - Interventional Cardiology
 - Interventional Urology

Lead Equivalence

Front Protection

Back Protection

0.50 mm Pb

0.35 mm Pb

0.25 mm Pb

Customization Options



Name Tag



Embroidery (in Pockets)



Thyroid Shield (Attachable Loop)

Accessories

Coat Apron

Coat Apron

Anti-skid Shoulder Pads to reduce stress & for equal weight distribution

Pockets Included

Also available Flex Back (Elastic belt provides lumbar support & improved fit)

Complete frontal protection



Velcro Closure for a Enhanced Fit

Protection Area

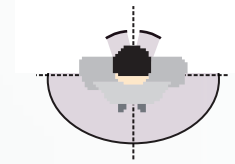

- Fabric Type -

- Satin touch**
Smooth • Comfortable • Hygienic
- Maxin Fabric**
- SPACEED**
CERTIFIED SPACE TECH APRON

Ideal For

- Interventional Radiology Procedures

Lead Equivalence

Front Protection

0.50 mm Pb

0.35 mm Pb

0.25 mm Pb

Customization Options



Name Tag



Embroidery (in Pockets)



Thyroid Shield (Stitched & Integrated)

Accessories

Coat Apron with Front Snaplock

Coat Apron with Back Snaplock

Anti-skid Shoulder Pads to reduce stress & for equal weight distribution

Pockets Included

Wide Stretchable Wings, enables adjustments & provides a Snug Fit and Shoulder relief.

Front Snap Lock for proper fixation

Anti-skid Shoulder Pads to reduce stress & for equal weight distribution

Pockets Included

Complete Frontal Protection

Back Snap Lock for proper fixation

Protection Area

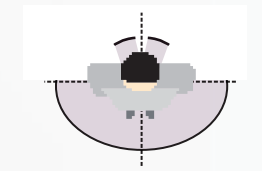

- Fabric Type -

- Satin touch
Smooth • Comfortable • Hygienic
- Maxin Fabric
- SPACEED
CERTIFIED SPACE TECH APRON

Lead Equivalence

Front Protection

- 0.50 mm Pb
- 0.35 mm Pb
- 0.25 mm Pb

Customization Options

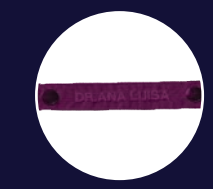

Name Tag

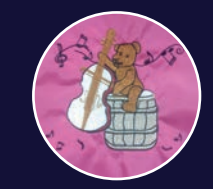

Embroidery (in Pockets)



Thyroid Shield (Stitched & Integrated)

Accessories

Anti-skid Shoulder Pads to reduce stress & for equal weight distribution

Pockets Included

Velcro Closure for a Enhanced Fit

Complete frontal protection



Protection Area

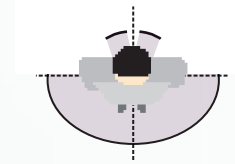

- Fabric Type -

Satin touch
Smooth • Comfortable • Hygienic

Maxin Fabric

SPACEED
CERTIFIED SPACE TECH APRON

Also available Flex Back (Elastic belt provides lumbar support & improved fit)

Ideal For

- Interventional Radiology Procedures

Lead Equivalence

Front Protection

0.50 mm Pb

0.35 mm Pb

0.25 mm Pb

Customization Options

Accessories



Name Tag



Embroidery (in Pockets)



Thyroid Shield (Stitched & Integrated)

C-Arm Pro Apron

C-Arm Pro Elite

Anti-skid Shoulder Pads to reduce stress & for equal weight distribution

Pockets Included

Velcro Closure for a Comfortable Fit

Complete Frontal Protection



Anti-skid Shoulder Pads to reduce stress & for equal weight distribution

Available with Integrated Thyroid Shield

Pockets Included

Complete Frontal Protection

Velcro Closure for a Comfortable Fit



Protection Area

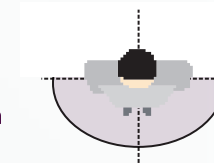

- Fabric Type -

Satin touch
Smooth • Comfortable • Hygienic

Maxin Fabric

SPACEED
CERTIFIED SPACE TECH APRON

Ideal For

- Fluoroscopy Equipment
- Interventional Radiology Procedures

Available in Tangerine & Royal Blue Color Combination

Lead Equivalence

Front Protection

0.50 mm Pb

0.35 mm Pb

0.25 mm Pb

Customization Options



Name Tag



Embroidery (in Pockets)

Dental Protective Apparel

Dental Aprons

Designed for complete protection while being X-Rayed on a dentist's chair

The apron drapes comfortably over patient, covering sensitive areas from exposure to scatter radiation during radiography.

Both Adult & Child sizes are available

Available with thyroid collar attached option (Velcro / Magnetic Closure)

Model	Dimensions			
	Adult		Child	
	L cm	W cm	L cm	W cm
Economy	70	60	60	40
Standard	80	60	60	45
Premium	90	60	70	45



Lead Equivalence

0.35 mm Pb

0.50 mm Pb

Panoramic Apron

Economy

Optimum protection during Panoramic Radiography

Split in back with Velcro closure for adjustable fit

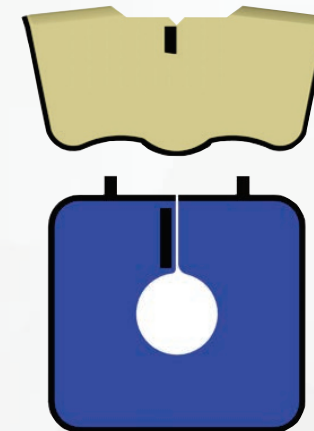

Standard

Complete Front Protection, Optimum Back protection

Split in back

Available with Velcro/ Magnetic Lock



Lead Equivalence

0.25 mm Pb

0.35 mm Pb

0.50 mm Pb

Premium

Extended & Equal protection on both front & back

Velcro closure on shoulder



Model	Dimensions			
	Adult		Child	
	L cm	W cm	L cm	W cm
Economy	35	60	-	-
Standard (Front)	80	55	-	-
Premium (Front & Back)	80	60	60	45

Lead Equivalence

0.35 mm Pb

0.50 mm Pb

Technician Apron

- Provides protection to the dental staff during radiography.
- Adjustable strap and buckle for more secure, ergonomically superior fit



Model	Dimensions	
	Adult	
	L cm	W cm
Standard	100	60
Premium	110	70

Lead Equivalence

0.35 mm Pb

0.50 mm Pb



Coat Apron

Coat Apron with Thyroid

Dental Apron

Dental Apron with Thyroid

Front Protection

Back Protection

Front Protection

0.50 mm Pb

0.35 mm Pb

0.25 mm Pb

0.30 mm Pb

0.35 mm Pb

0.50 mm Pb



PROTECTIVE SHIELDS

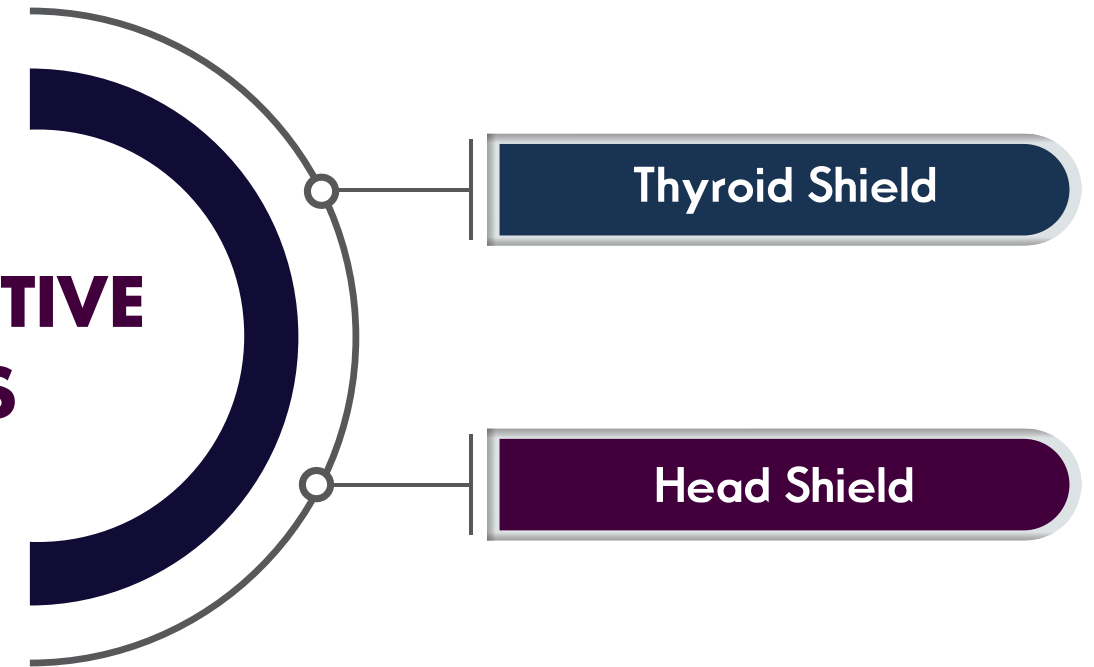

Thyroid Shields

Kiran's wide range of thyroid shields provide complete protection to the neck and sternum from ionizing Radiations.

Thyroid Shields

Ultraslimline

Ergonomic design for comfort

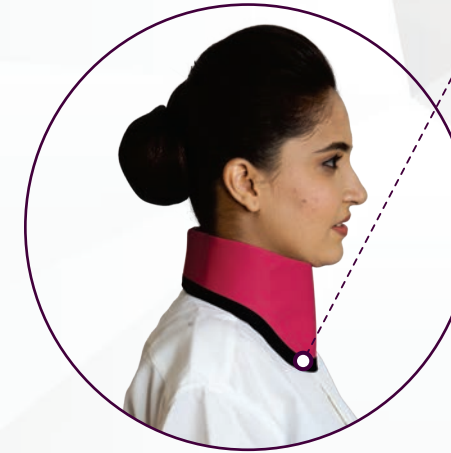

Easy to attach with all the Apron variants



Velcro/Magnetic Closure

Classic



All-time popular design
 Wide Coverage Area
 One size fits all
 Velcro Closure

Elegant



Easy to attach with Kiran's Double Sided Apron & Vest
 Adjustable fastener
 Velcro Closure

Slimline



Provides perfect fit and protection
 Easy to attach with all the apron variants
 Velcro Closure
 Also available with Magnetic Closure

Harmony



Collar design which perfectly fits thyroid gland
 Velcro Closure

Lead Equivalence

0.50 mm Pb

0.35 mm Pb

Head Shield



Designed for ease of wearing and removal

The head and ears stay safe, inside head gear, from radiations



Also Available Disposable Head Shield

Optima

Flexible & Supple



Maxima

Complete protection from scattered radiation



Lead Equivalence

0.25 mm Pb

0.35 mm Pb

0.50 mm Pb

1.00 mm Pb

Gonad Shield

Ideal to protect the male reproductive organ



Designed for ease of wearing & removal with adjustable Velcro Panel

Available in one-size-fits-all & child size

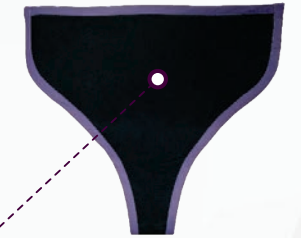

Lead Equivalence 0.50 mm Pb, 1.00 mm Pb

Ovarian Shield

Designed for ease of wear & removal with adjustable Velcro Panel



Ideal to protect the female reproductive organ

Available in one-size-fits-all & child size



Lead Equivalence 1.00 mm Pb



PROTECTIVE ACCESSORIES

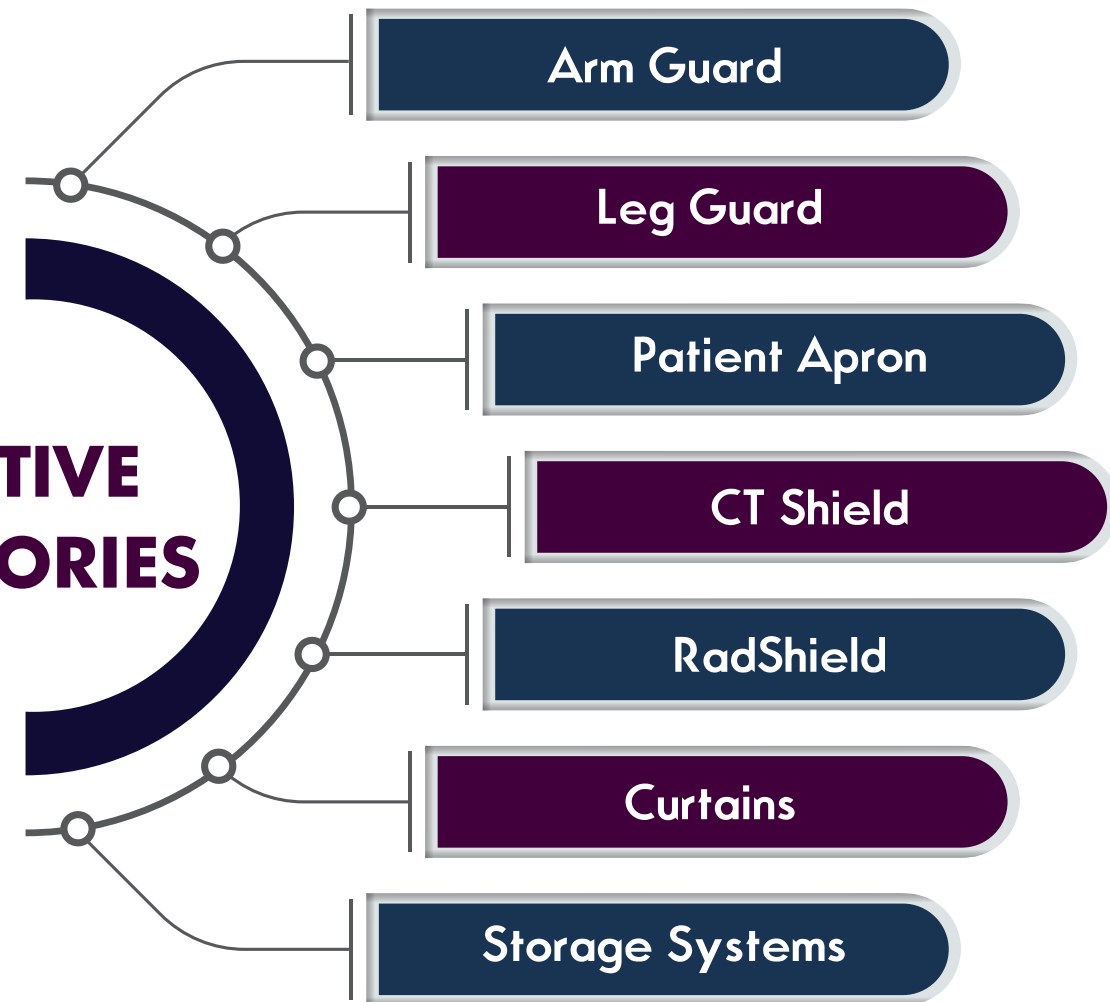

Arm Guard

Kiran Arm guard offers protection to the upper part of the body from scattered radiation.

- Prevents radiation from being scattered to the shoulders and arms
- Can be attached with hook-and-loop fasteners and a snap
- Can be paired with wrap around styles apron and vest
- Can be used in all radiology procedures
- One size fits all



Leg Guard

Kiran Leg guard offers complete protection to the lower part of the body from scattered radiation.

- Protects the Leg from radiation exposure
- Velcro Closure for easy adjustments
- One size fits all



Patient Apron

Patient apron is apron used for protection of patient from direct /scattered radiation while getting examined under X-Ray table.

- Universal use as gonad and ovarian shields
- Complete lower body protection
- Designed to provide comfort and adequate protection
- Adjustable back strap for snug fit
- Child Size Available

Dimension

30×30 cm, 40×40 cm, 50×50 cm

Patient Apron (without belt)



Customization



Available with Ring Attached

Lead Equivalence

0.50 mm Pb

0.35 mm Pb

Lead Equivalence

1.00 mm Pb

0.50 mm Pb

CT Breast Shield

Designed to protect the sensitive breast area and reduce cancer risk due to large radiation doses during CT.

Today, cancer is affecting younger population of women, with the highest risk being to women under the age of 35. CT scans and similar doses of radiation increases cancer risk, making it essential to conduct research on new radiation protection methods.

Kiran applied its expertise in radiation protection to develop the breast shield that is used in plane breast shielding to reduce cancer risk.

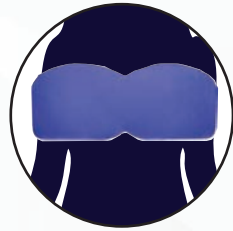

Offers 67% protection to the sensitive tissue of the breast



Eco-Friendly



Helps prevent breast cancer



Disposable



Available with a foam pad for comfort



Various sizes available

CT Pediatric Shield

Designed to protect infants and children from radiation doses emitted during CT scans, without any compromising to image quality.

Infants are ten times more susceptible to carcinogenesis caused by radiation exposure than adults.

Kiran's Pediatric shield designed to protect infants and children from radiation doses emitted during CT scans, without any compromise to image quality.



Offers 67% protection to the sensitive tissue of the breast



Eco-Friendly



Helps prevent breast cancer



Disposable



Available with a foam pad for comfort



Available in Neonatal, 1,5 & 10 Year old

CT Eye Shield

Designed to protect the eye, which becomes especially sensitive to radiation after repeated CT procedures.

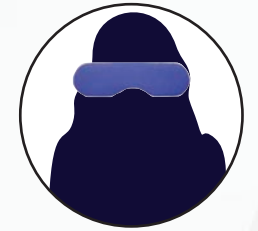

70% protection to the complete eye



Perfect fit to prevent accidental exposure to radiation



Disposable



Design to mould to the eye's shape



One Size fits all



Eco-Friendly

CT Thyroid Shield

Designed to provide special protection to sensitive thyroid gland.

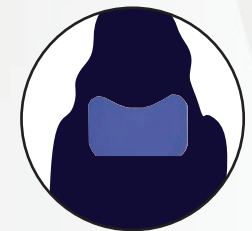

Offers 65% protection to thyroid gland



Prevents tissue damage



Disposable



One Size fits all



Eco-Friendly

Attenuation tests performed in accordance with EN 61331-1:2014

With the concerns of Interventional Specialists in mind, Kiran has designed RadShield which is an inevitable solution to minimize the Cumulative Career exposure. These shields are placed on the patient's body and positioned to block scattered radiation in all Cath Lab procedures.

The Rad Shield Solution

- Placed on patient to protect physician from X-ray scatter radiation and provides sterile surgical barrier to the patient
- Made from proprietary mix of several lead-free elements
- Helps in preventing cancer risks and radiation damage
- Designed to allow physician to conduct surgery without any hindrance
- Used for general & interventional procedures
- 100% sterilized with the latest ethyl oxide radiation sterilization
- Single Use and easy to dispose

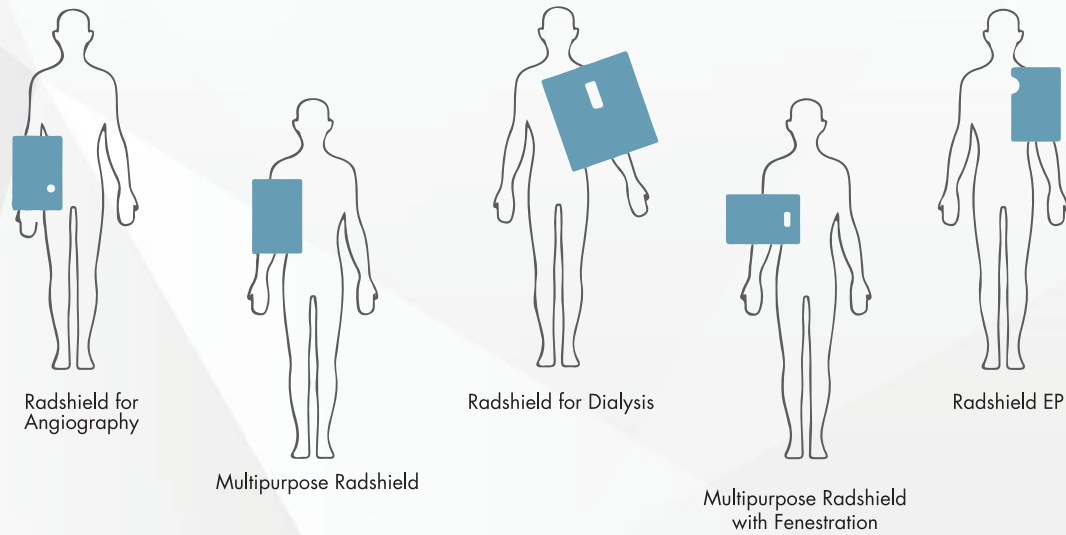

Equivalence (mm Pb)	Type	Minimum Attenuation @90 kVp
0.125	LOW (L)	75.3%
0.250	MEDIUM (M)	90.8%
0.350	HIGH (H)	95.3%

Attenuation tests performed in accordance with IEC 61331-1:2014 & ASTM F 2547

Health Hazards faced by Interventionists

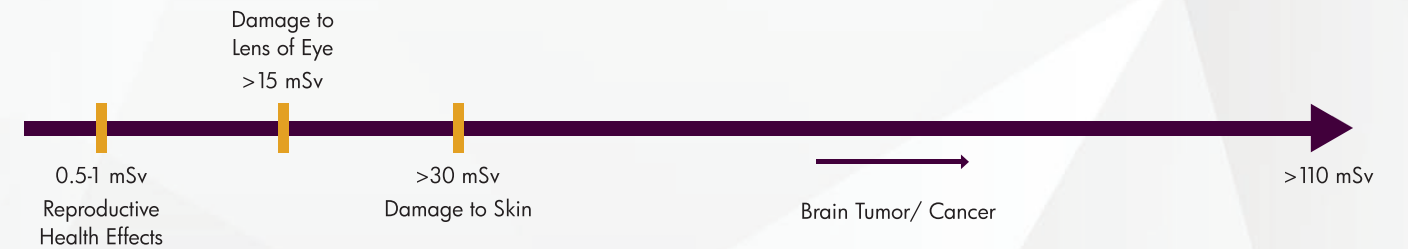
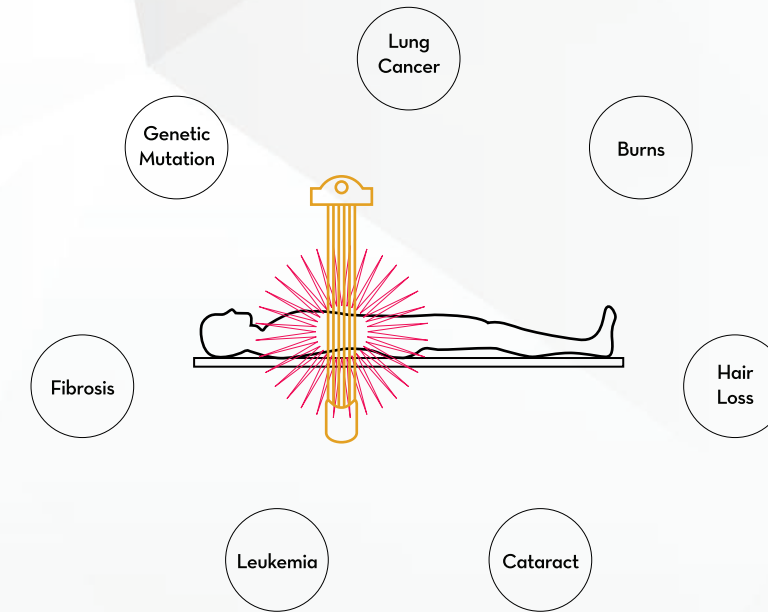

Deterministic Effects

- Exposure to large dose of radiation for a short period of time
- Eg. Skin Erythema, Hair loss, Radiation burns and Acute Radiation Syndrome
- Eg. nausea, vomiting and dizziness

Stochastic Effects

- Prolonged exposure to low dose scattered radiation with the disease manifesting after years or even decades
- Eg. Cancer, Bone-marrow damage, Genetic mutation

Every time an Interventional Cardiologists walks out of the Operation Room, the morale of the patients and relatives go up. So does the cumulative radiation exposure the specialist has acquired right from beginning of their career.

In a Career spanning 30 years, Interventional cardiologists, radiologists and technicians are exposed to more ionizing radiations than physicians in any other specialized medical field.

- A Cumulative Career Radiation Exposure for Surgeons is 108 mSv and 45 mSv for Technicians /Nurse.
- According to BEIR VII (Biological Effects of Ionising Radiation Committee VII), the total cancer incidence receiving 2 mSv/y from 18 to 65 years of age should be 1 in 136

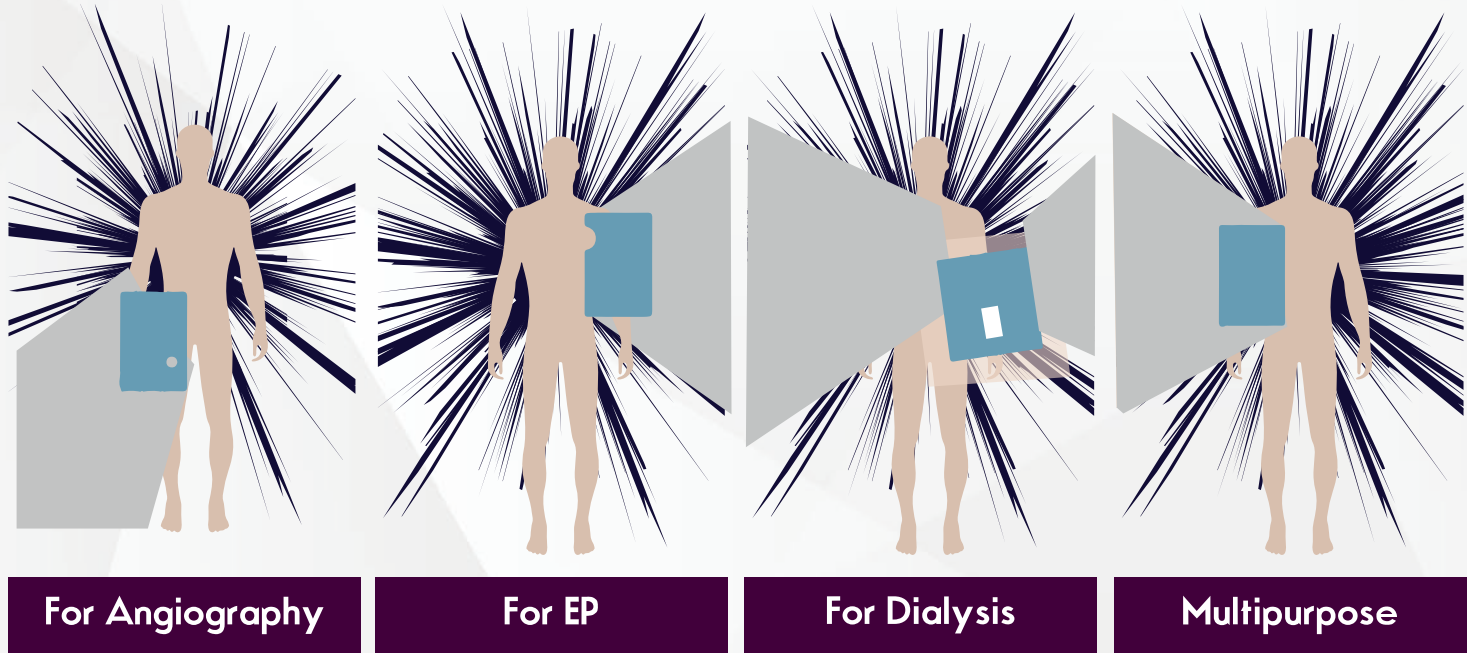

Scattered Radiation

In the case of Scattered Radiation, the X-Rays are specifically focused on a single target, the x-rays will still scatter and those scattered rays can continue to scatter around the room based on various design features.

Scatter radiation. The bulk of this type of radiation derives from the X-rays bouncing off the patient's body.

Back scatter. This type of scatter radiation is created from behind the film and directed back towards the X-ray tube.

Side scatter. Side scatter is caused by objects in the immediate areas, such as walls, floors and tables. To mitigate side scatter, you may have noticed that X-ray rooms are typically void of other objects and the table is located in the center of the space.

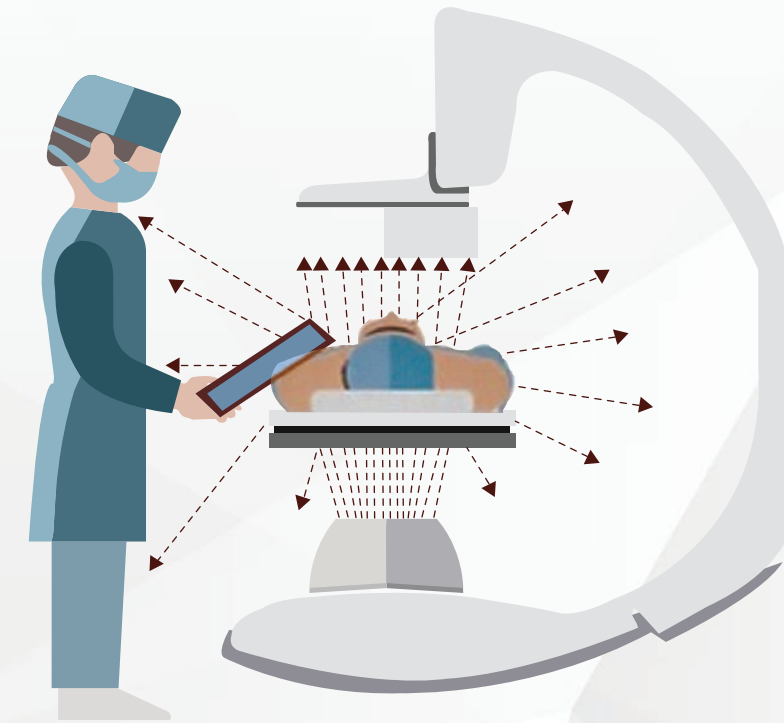

Typical Scatter Radiation Exposure Levels

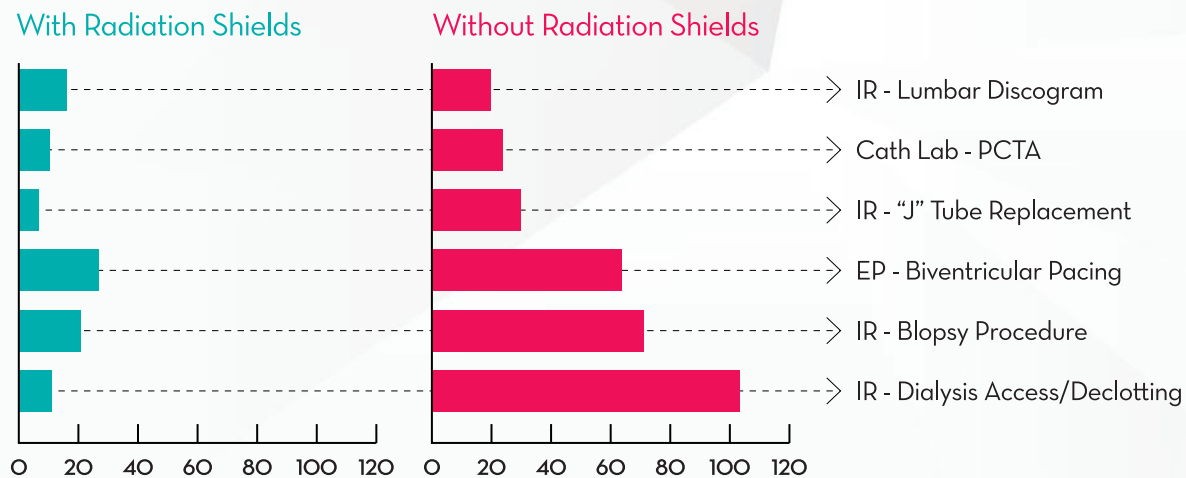

Scattered Radiation

RadShield (High)
0.350 mm Pb

Sample Designation	Minimum Attenuation			
	80 kVp	90 kVp	100 kVp	120 kVp

Radshield High Batch No: 35025082016	97.2%	95.4%	92.7%	89.4%
---	-------	-------	-------	-------

Sample Designation	Lead Equivalency (mm Pb)*			
	80 kVp	90 kVp	100 kVp	120 kVp

Radshield High Batch No: 35025082016	0.36	0.41	0.38	0.36
---	------	------	------	------

RadShield (Medium)
0.250 mm Pb

Sample Designation	Minimum Attenuation			
	80 kVp	90 kVp	100 kVp	120 kVp

Radshield High Batch No: 25025082016	93.3%	90.6%	87.0%	81.2%
---	-------	-------	-------	-------

Sample Designation	Lead Equivalency (mm Pb)*			
	80 kVp	90 kVp	100 kVp	120 kVp

Radshield High Batch No: 25025082016	0.27	0.27	0.26	0.24
---	------	------	------	------

RadShield (Low)
0.125 mm Pb

Sample Designation	Minimum Attenuation			
	80 kVp	90 kVp	100 kVp	120 kVp

Radshield High Batch No: 12525082016	81.2%	78.1%	71.5%	64.0%
---	-------	-------	-------	-------

Sample Designation	Lead Equivalency (mm Pb)*			
	80 kVp	90 kVp	100 kVp	120 kVp

Radshield High Batch No: 12525082016	0.13	0.14	0.13	0.12
---	------	------	------	------

*Uncertainty of Measurement: ±4%

Adjustable Mobile Shield

Put the protection where you need it, at any height

Ideal for patients undergoing standing diagnostic procedures, the Adjustable Mobile Shield can be set between 36" and 60" high

It is easy to move in any direction



Lead Curtain

Lead Curtain which block the scattered radiations. Lead Curtain are useful in fluoroscopy suites, emergency rooms, hospitals, industrial radiography locations, and where low-level or secondary radiation is present

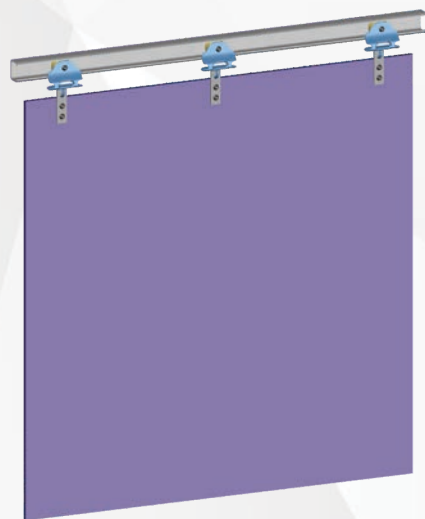

Table Shield

Table Shield offers maximum protection from under table scattered radiation. The design allows the shield to be instantly used on either side of the X-ray table with the pivotal arm always facing the head end

The upper shield is detachable and can be removed in the event of a patient emergency. The Table Shield can be easily adjusted for both left- or right-hand side applications



Lead Curtain

The protective blankets – which is for shielding patient and equipments



Color

Available in royal blue color & Customizable

Dimension

Customizable

Lead Equivalence

0.50 mm Pb
1.00 mm Pb

Color

Available in royal blue color & Customizable

Dimension

Customizable

Lead Equivalence

0.50 mm Pb
1.00 mm Pb

Table Drapes

Table Drapes is a lower shield which protect the patient body from scattered radiation

Hook and-loop fastener attachments make these drapes a breeze to attach to any style table setup

Available in the single-sided option, or double the protection with the double-sided drapes design

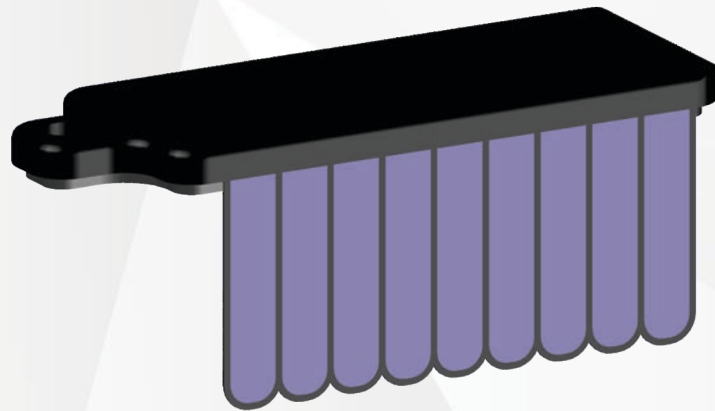
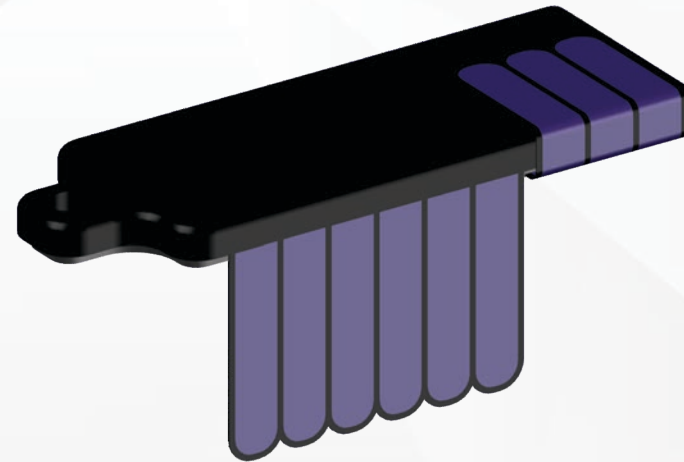

Apron Hanger

Coated Steel Hanger for use with adult and child X-ray aprons

Composed of Low Carbon Steel, Poly Urethane Plastic Blue Caps and Toggle Bolts

Dimension

3.2 cm (W) X 38 cm (L) X 3.5 cm (H)

Part Name	Material	Quantity
Hanger	Low Carbon Steel	1
Blue Cap	Poly Urethane Plastic	4
Toggle Bolt	As Mentioned Below	3

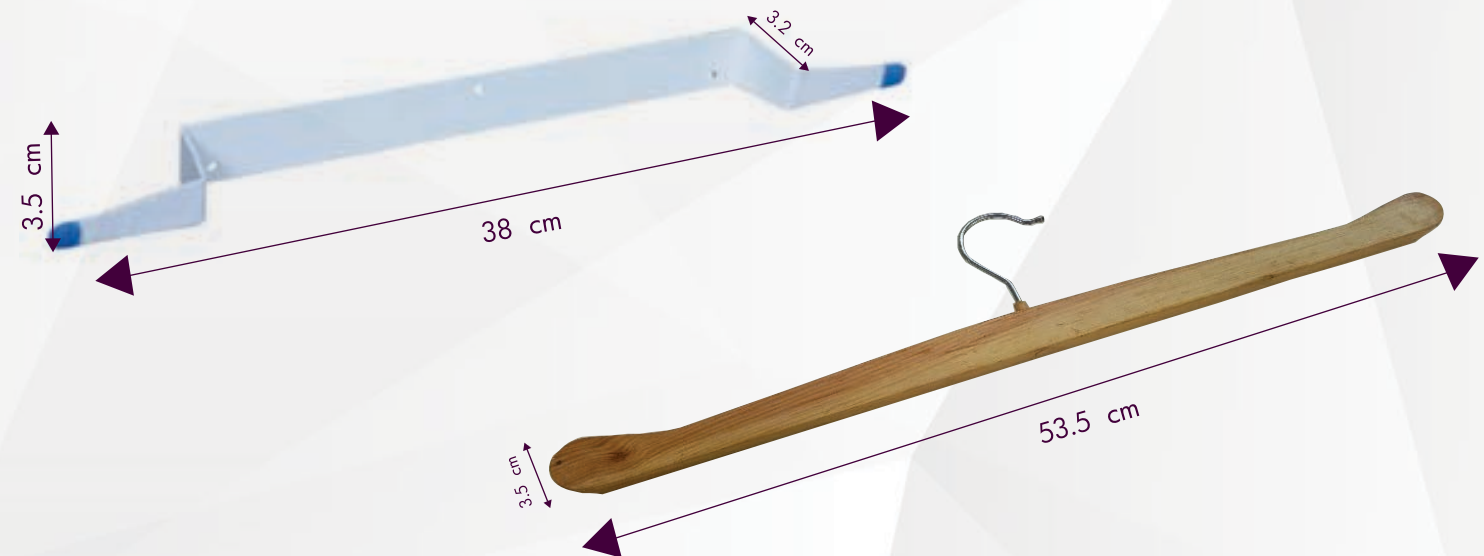

Color

Available in royal blue color & Customizable

Dimension

Customizable

Lead Equivalence

0.50 mm Pb
1.00 mm Pb

Mobile Storage System with Hangers

A Compact, Space saving and easy to install unit for storing apparels, gloves and shields

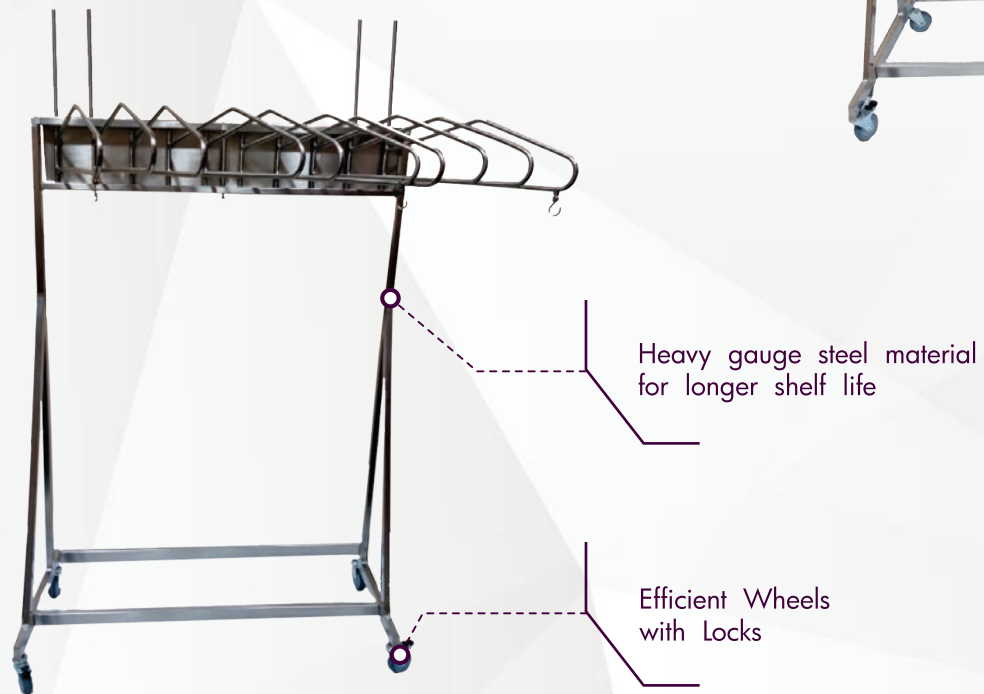

Mobile Storage System

- 10 Hangers
- 2 Glove Holders

Mobile Storage System

- 5 Hangers
- 2 Glove Holders

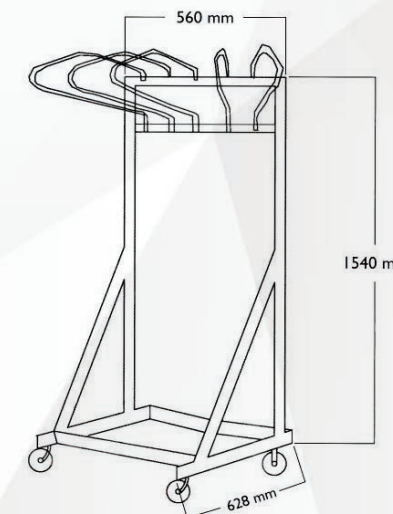

Available Models

10 Hangers & 2 Glove Holders
Stores upto 10 Pairs of apparels

5 Hangers & 1 Glove Holder
Stores upto 5 Pairs of apparels

Wall Mounted Racks

A Compact, Space saving and east to install Wall Racks for storing apparels, gloves & shields.



Available Models

Wall racks with 1,2,3 & 5 Hanger options

Hooks are available for fixing on a wall racks

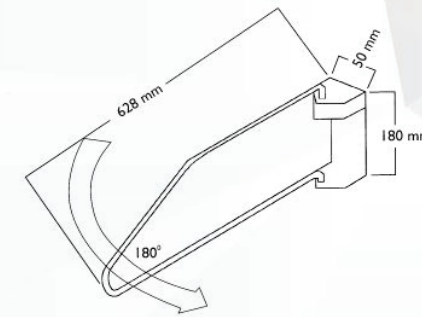

One hanger wall rack (left to right)

- Stores the apparel closest to the wall
- Available with one swivel hanger

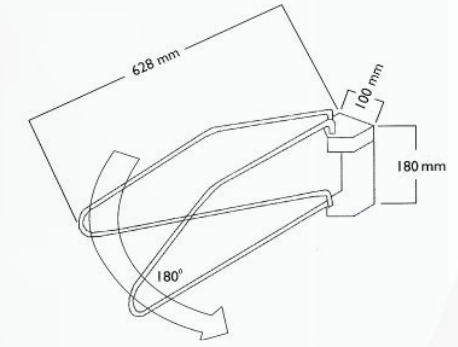

Two hanger wall rack (left to right)

- Wall bracket flush on the left or right for storing two apparels
- Optimum use of available space

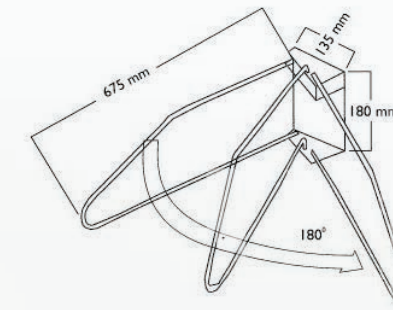

Three hanger wall rack (left to right)

- Wall bracket flush on the left or right for storing three apparels
- Optimum use of available space

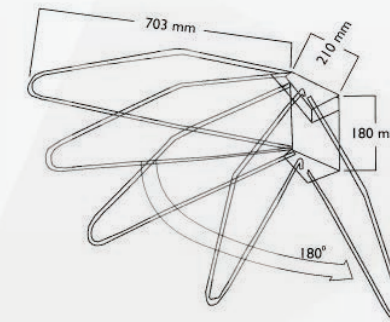

Five hanger wall rack (left to right)

- Wall bracket flush on the left or right for storing five apparels
- Optimum use of available space

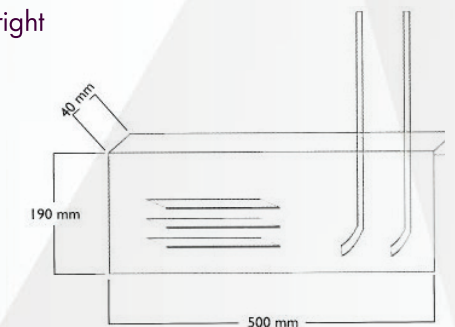

Wall mounted Glove holder

- Wall mounted glove holder for storing gloves
- Optimum use of available space

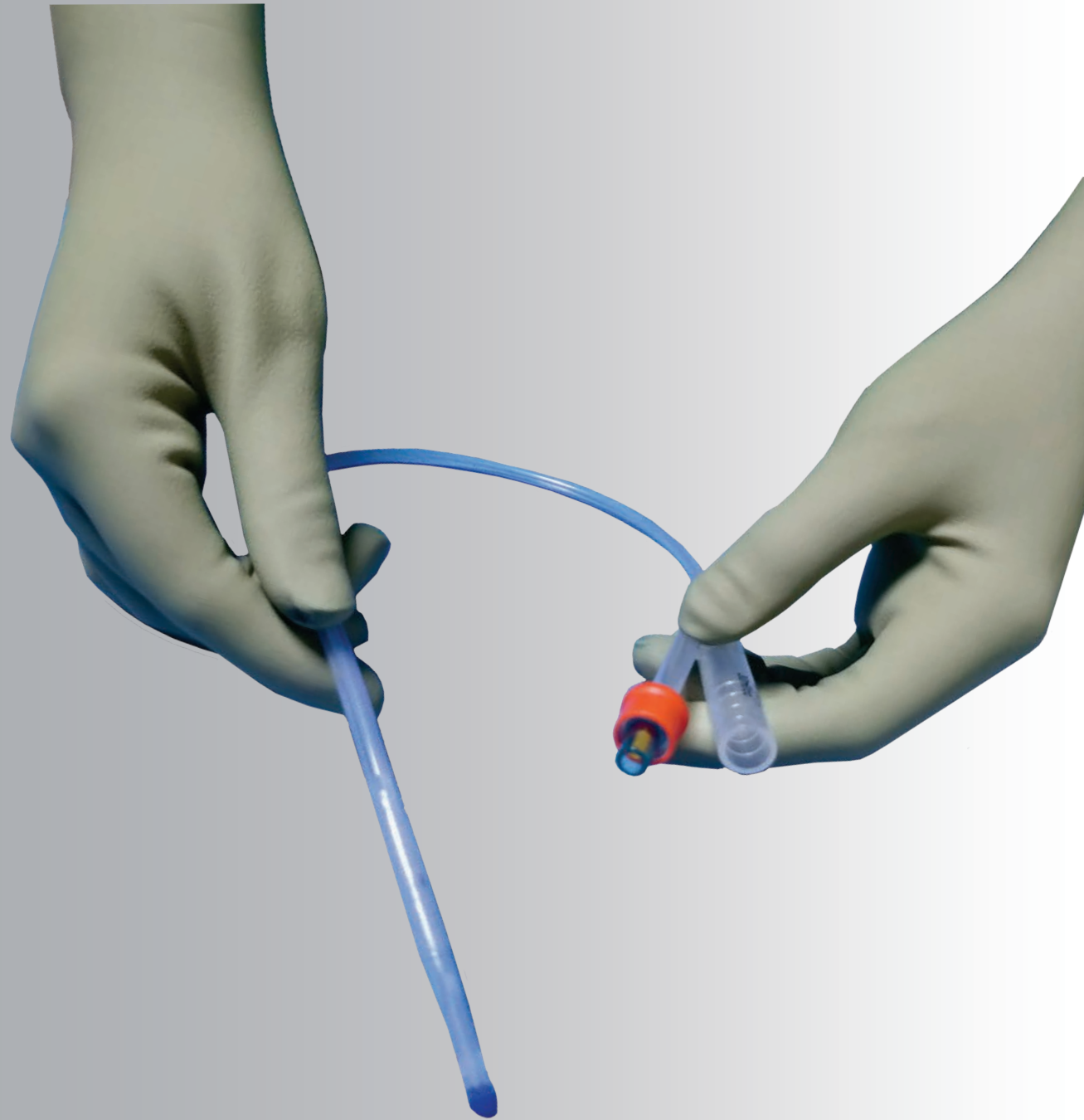

RADIATION PROTECTION GLOVES

Protection | Grip | Comfort

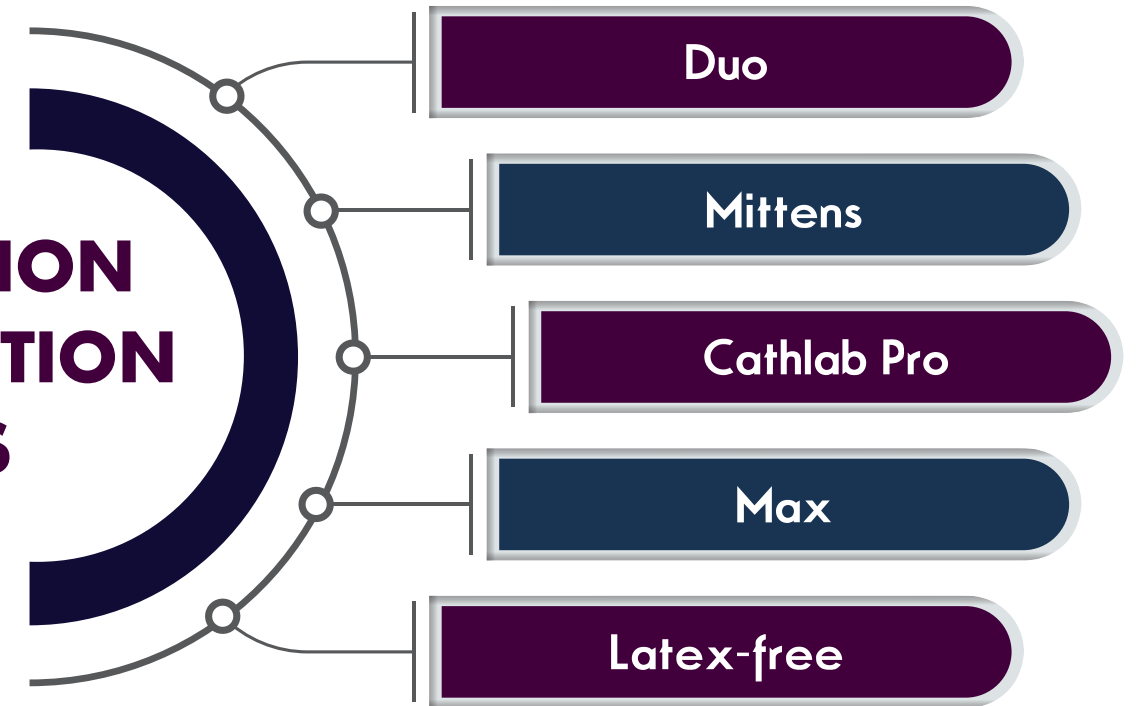

Radiation Protection Gloves

Reusable Lead Gloves

Made of soft, pliable material, Kiran gloves are non-sterile, protective, comfortable, and usable.



Lead Equivalent thickness in mm Pb

0.50



Lead Equivalent thickness in mm Pb

0.25 / 0.35 / 0.50

Duo

Our dual-layered gloves have a seamless external covering and an internal lining, all of which can be dismantled and cleaned.

Measured with narrow as well as inverse broad beam geometry condition at 150 KVp, in accordance with EN 61331-1:2014 & EN 61331-3:2014

Ideal For

Proper positioning in Veterinary & Pediatric X-Ray

Mittens

Mittens, one of our bestsellers, allows wearers the mobility of using their bare hands directly in beam field, thanks to protective mitten design and snug internal strap.

Measured with narrow as well as inverse broad beam geometry condition at 150 KVp, in accordance with EN 61331-1:2014 & EN 61331-3:2014

Ideal For

Technicians hand protection during intervention cardiology procedures

Sterile Lead Free Radiation Protection Gloves

Kiran offers a wide range of sterile Lead-Free and disposable radiation protection gloves that provide the highest possible protection in Surgical procedures and are easy to dispose in an eco-friendly manner

Produced at our independent sterilization facility, each glove is subjected to rigorous contamination control and is 100% sterilized using the latest gamma sterilization equipment and complies with International quality standards.



Cathlab Pro

Ideal for use in Interventional Cardiology Procedures



Max

Ideal for use in Fluoroscopy / Orthopaedic / Urology Procedures



Latex-free

Ideal for use in Interventional Cardiology Procedures

Available Size

L

Length of the glove in cm

38

Half circumference of the glove on cuff/palm in cm

18.5 / 14

Half circumference of the hand of the user in cm

9



Proprietary hypoallergenic formulation for complete protection



Textured external surface for Superior Grip



Multiple Lead Equivalence & thickness options for various Clinical applications



Flexible & Powder free material for comfort & durability



Composed of a Proprietary mixture of Lead-free elements, making them safe for the environment and for users



Easily disposable material for one-time use

Characteristics

Technical Parameters	Max NXP35	Thin NXP25	Ultrathin NXP20	Cathlab Pro CNXP20	Latex-free SXP20
Finger tip thickness (mm/mils)	Min. 0.35	Min. 0.25	Min. 0.20	Min. 0.20	Min. 0.25
Palm thickness (mm/mils)	Min. 0.32	Min. 0.24	Min. 0.19	Min. 0.19	Min. 0.24
Cuff thickness (mm/mils)	Min. 0.30	Min. 0.22	Min. 0.18	Min. 0.18	Min. 0.22
Lead equivalence (mm Pb)	Min. 0.04	Min. 0.025	Min. 0.02	Min. 0.02	Min. 0.025
Color	Khaki	Khaki	Khaki	Yellow	Brown
Material	Natural Latex with hypoallergenic inner coating				Synthetic Latex
Tensile strength (MPa)	Min 14				
Minimum elongation (%)	700				
Protective material	Mixture of lead-free elements				
Donning agent	Powder free				
Azo dyes	None				
Residual powder	≤ 2mg/glove				
Protein content	Less than 50 micrograms/gram				
Sterilization	Gamma sterilization				
Packing	One sterile pair per pouch				
Storage	Store in cool, dry place away from Ozone (Below 25°C) 40-50% RH				

Specifications

Size	Minimum Length (mm/inches)	Palm Width (mm/inches)
6	280/11.0	78/3.1
6.5	280/11.0	80/3.1
7	280/11.0	85/3.3
7.5	280/11.0	94/3.7
8	280/11.0	100/3.9
8.5	280/11.0	107/4.2
9	280/11.0	114/4.5

*Uncertainty of Measurement: ±4%

% Attenuation as per ASTM-2547-18

Radiation Beam Energy Level	Skin Dose Reduction			
	Max NXP35	Thin NXP25	Ultrathin NXP20	Cathlab Pro CNXP20
60 kV	55%	51%	46%	39%
70kV	50%	46%	42%	35%
80 kV	45%	41%	38%	32%
90 kV	41%	38%	34%	29%
100 kV	39%	35%	32%	27%
110kV	36%	34%	30%	25%
120 kV	35%	32%	28%	24%
130kV	33%	30%	27%	22%

Kiran's World-Class Glove Manufacturing Line





Light & Comfortable

Ease of Wearing of
long durations

Absorbs Lead Glass

Absorbs 99 %
radiation

Wide Range of Models

Designed for
differing application

EYE PROTECTION

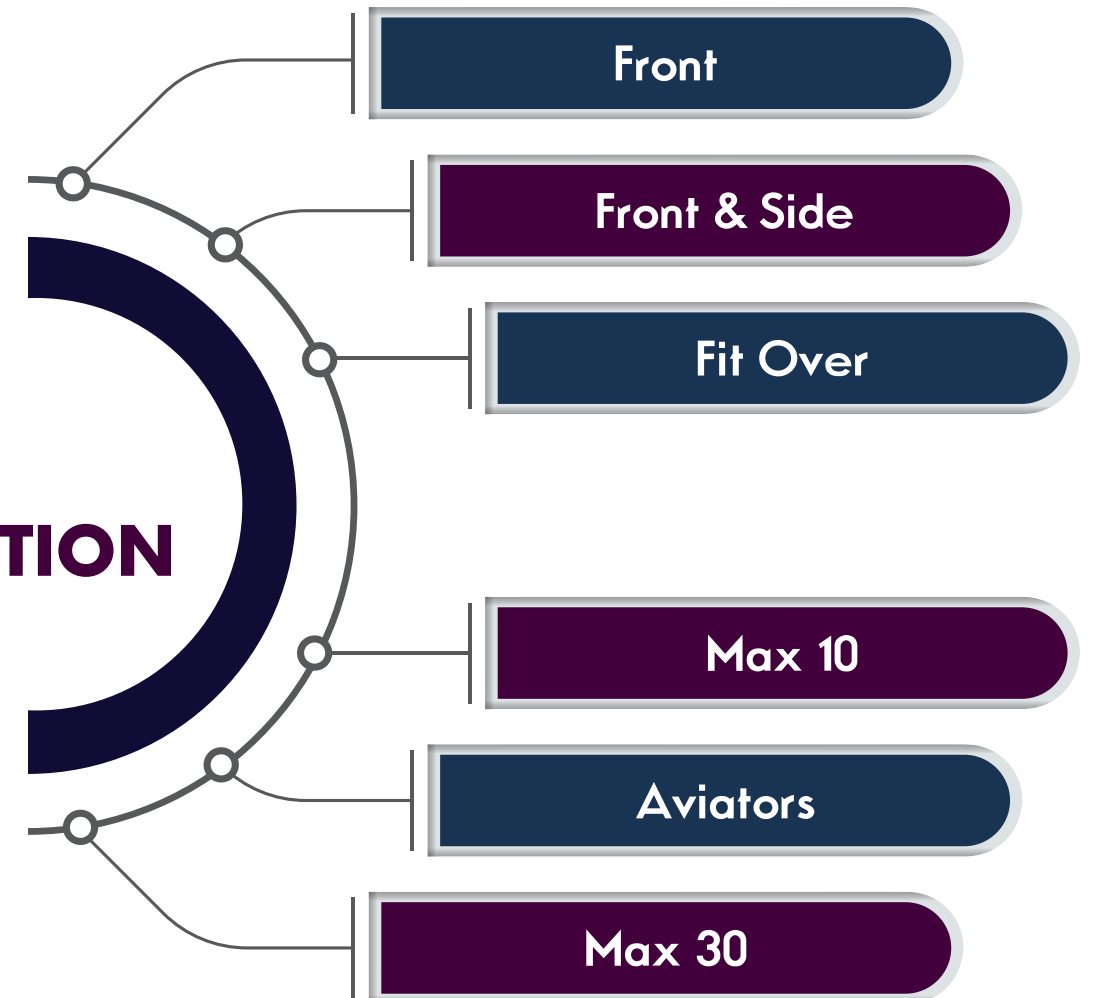



1. Nose Pads

Soft nose pads provide comfort to the user during long procedures. It is available with adjustable nose pads and adjustable bridges

2. Nose Bridge

Nose bridge keeps the frame evenly balanced

3. Temple Grips

Rubber temple grips with different eyewear styles offer non-slip, comfort grip support

4. Glass

Contains minimum 0.75mm Pb equivalent leaded glass providing 95 percent attenuation up to 150 kVp

Front

Complete Frontal Protection

- Offers a stylish wrap around frame
- This Frame fits best for medium and large style heads.

Weight

85 g



Key Benefits

0.75 mm lead Equivalency

Rubberized soft grip

Nose pads for secure fit

Front & Side

Protection from frontal as well as Lateral Protection

- Offers large view area and side shield provides additional lateral protection.
- The Frame features a silicone no slip, unifix bridge with adjustable nose pads for increased comfort.
- This Frame fits best for medium to large style heads.

Specification

Eye Size 51 mm | Nose Bridge Width 20 mm | Temple Length - 140 mm

Weight

90 g



Key Benefits

0.75 mm & 0.50 mm lead equivalency lateral protection

Flexible temple bars & acetate frame

Adjustable Nose pads

Wide Range of Eyewear

Fit Over

Fits perfectly over the wearer's existing eyeglasses

- Offers a comfortable, lightweight, and durable design that fits over prescription eyewear
- This Frame fits over almost any style of glasses and head size with comfort

Specification

Eye Size 62 mm | Nose Bridge Width 15 mm | Temple Length - 145 mm

Weight

85 g



Key Benefits

0.75 mm lead Equivalency

Ultimate fit over design for weight & comfort

Max 10

Protection & Comfort with padding for the temple & bridge of the nose

- Offers a stylish wrap around frame
- This Frame models fits best for medium and large style heads

Specification

Eye Size 64 mm | Nose Bridge Width 16 mm | Temple Length - 140 mm

Weight

67 g



Key Benefits

0.75 mm lead Equivalency

Rubberized soft grip temple bars & nose pads for secure fit

Nose pads for secure fit

Wide Range of Eyewear

Aviators

Wraparound style eyeglasses with protection & stylish design

- A classic Radiation Protection Frame that is solid, sturdy and comfortable
- Its lateral shield protect around the orbit of the eye with 0.35mm lead equivalency

Specification

Eye Size 57 mm | Nose Bridge Width 16 mm | Temple Length - 125 mm

Weight

70 g



Key Benefits

0.75 mm lead Equivalency

Rubberized soft grip temple bars & removable nose pads for secure fit

Max 30

Unisex models that's fits all faces & shapes

- Offers a stylish wrap around frame style with a removable foam insert.
- This Frame fits best for small to medium style heads.

Specification

Eye Size 55 mm | Nose Bridge Width 20 mm | Temple Length - 140 mm

Weight

69 g



Key Benefits

0.75 mm lead Equivalency

Rubberized soft grip temple bars & nose pads for secure fit

Rubberized foam insert with fog reducing ventilation ports.

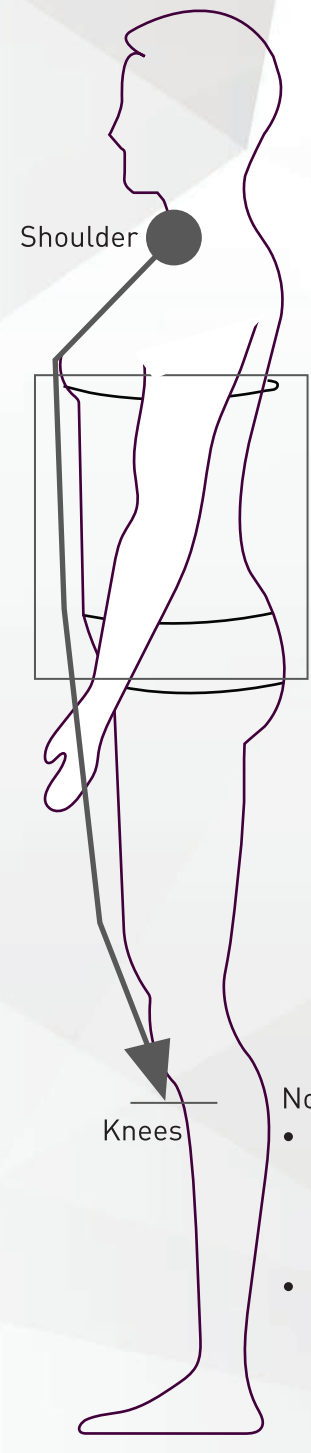
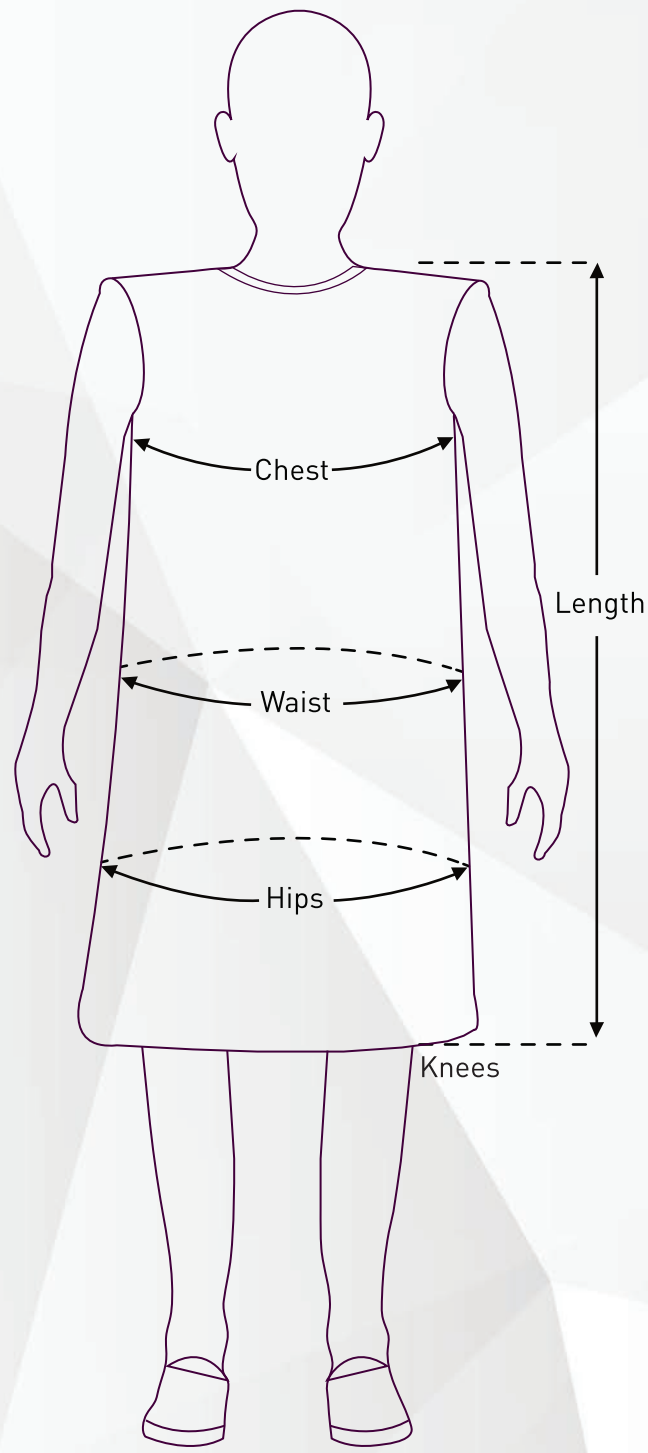

- Note:
- Girth of Operator - Consider the highest circumference out of the Chest / Waist / Hips
 - Length should be measured from Shoulder to Knee (upto 10 cm below the Knee)

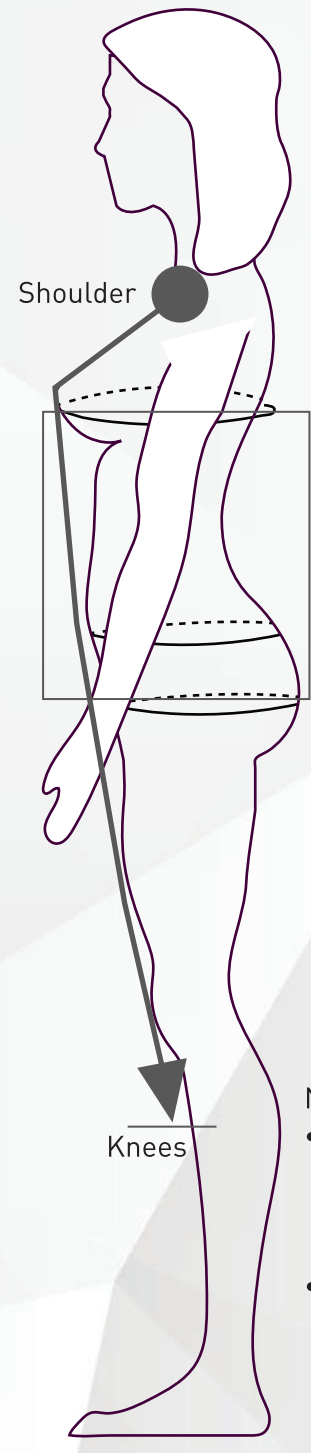
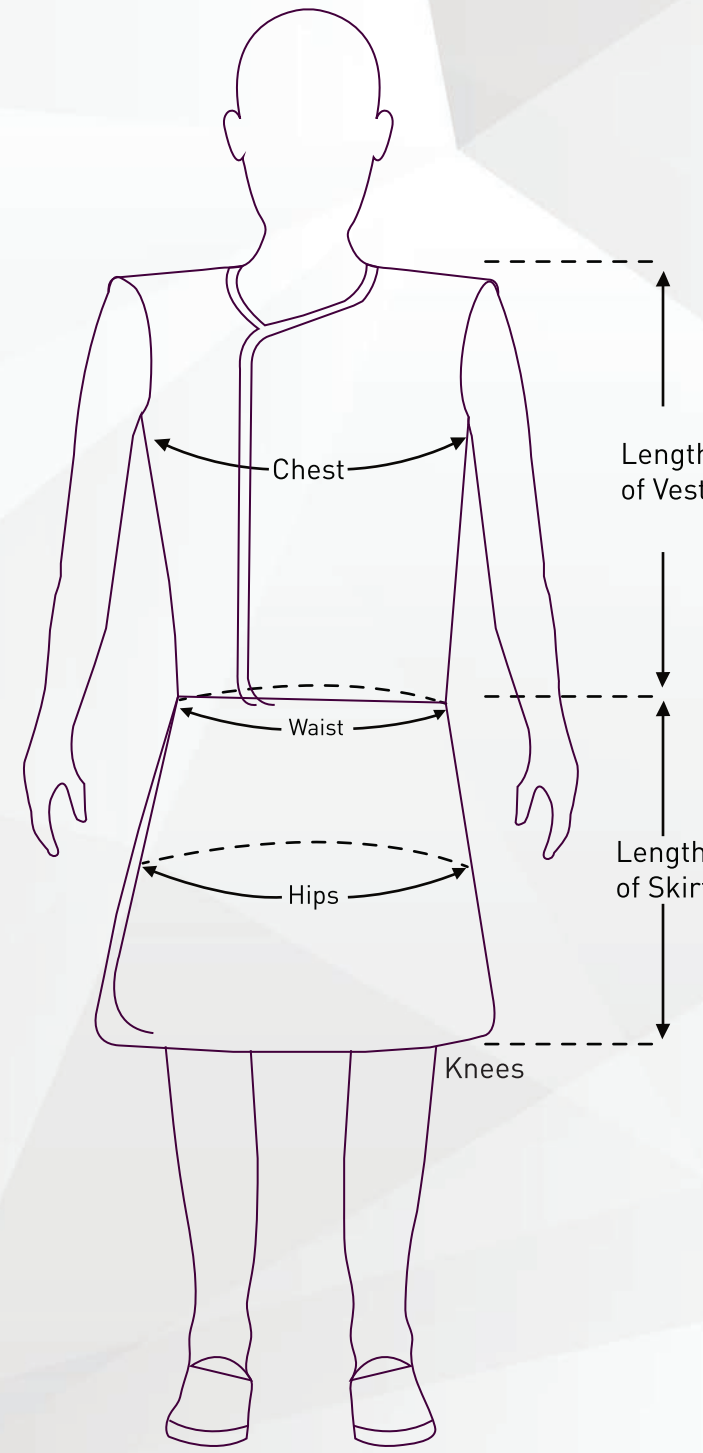

- Note:
- Girth of Operator - Consider the highest circumference out of the Chest / Waist / Hips
 - Length should be measured from Waist to Knee (upto 10 cm below the Knee)

Double Sided Apron

We have 8 digits in Kiran Code

Step 1

Digit 1&2
Radiation Protection Apparel = X1

Step 2

Digit 3
Double Sided Apron = 2

Step 3

Digit 4
For Double Sided Apron: Optima = 1
Maxima = 2

Step 4

Digit 5
Ultralite = 1
Zerolead = 2
Leadlite = 3
Zerolead Air*

Step 5

Digit 6
0.25 mm Pb Front / 0.25 mm Pb back = 5
0.35 mm Pb Front / 0.25 mm Pb back = 6
0.50 mm Pb Front / 0.25 mm Pb back = 7
1.00 mm Pb Front / 0.25 mm Pb back = 8

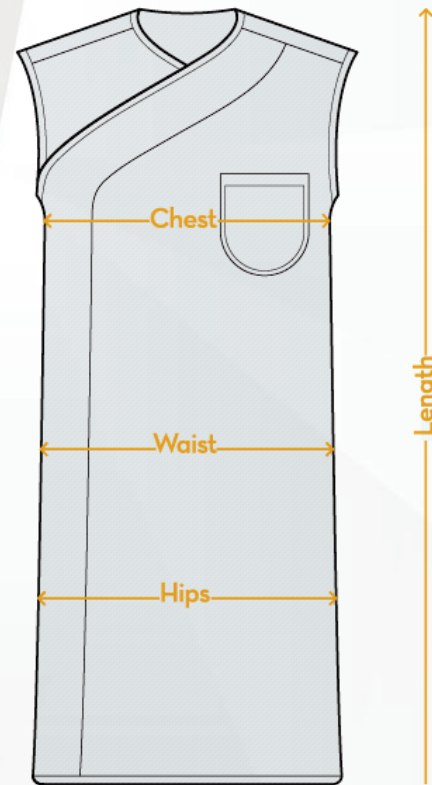

Example

Name / Mr. XYZ

Department / XY

Code / X12137C2



Step 6

(Digit 7)

Size	Width of DSA	
	Girth of Operator	Our Size (Digit 7)
XS	80-85	B
S	86-91	1
M	92-97	C
L	98-107	2
XL	108-113	3
XXL	114-120	E
XXXL	121-127	4

Step 7

(Digit 8)

Length of DSA
Our Length (Digit 8)
85 cm = B
90 cm = 1
100 cm = 2
105 cm = D
110 cm = 3
115 cm = E
120 cm = 4

*ZeroLead Air variant is available in select geographies. Please get in touch with your Kiran representative for more details.

Vest

We have 8 digits in Kiran Code

Step 1

Digit 1&2

Radiation Protection Apparel = X1

Step 2

Digit 3

Vest = 4

Step 3

Digit 4

For Vest: Optima = 1
Maxima = 2

Step 4

Digit 5

Ultralite = 1
Zerolead = 2
Leadlite = 3
Zerolead Air*

Step 5

Digit 6

0.25 mm Pb Front / 0.25 mm Pb back = 5
0.35 mm Pb Front / 0.25 mm Pb back = 6
0.50 mm Pb Front / 0.25 mm Pb back = 7
1.00 mm Pb Front / 0.25 mm Pb back = 8

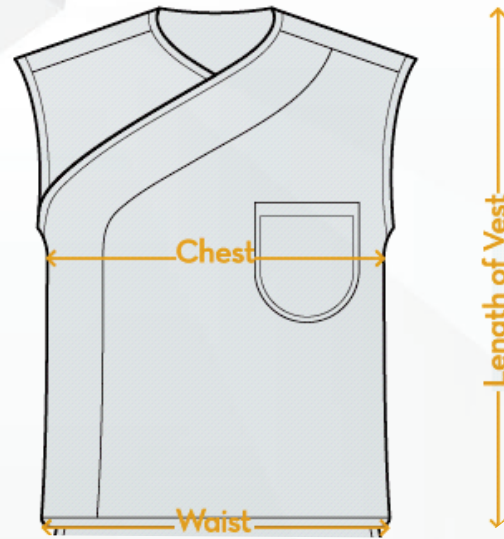

Name

Department

Code



Step 6

(Digit 7)

Size	Width of Vest	
	Girth of Operator	Our Size (Digit 7)
XS	80-85	B
S	86-91	1
M	92-97	C
L	98-107	2
XL	108-113	3
XXL	114-120	E
XXXL	121-127	4

Step 7

(Digit 8)

Length of Vest
Our Length (Digit 8)
42 cm = A
50 cm = 1
57 cm = 2
63 cm = 3
68 cm = 4
72 cm = 5
75 cm = F

*ZeroLead Air variant is available in select geographies. Please get in touch with your Kiran representative for more details.

Skirt

We have 8 digits in Kiran Code

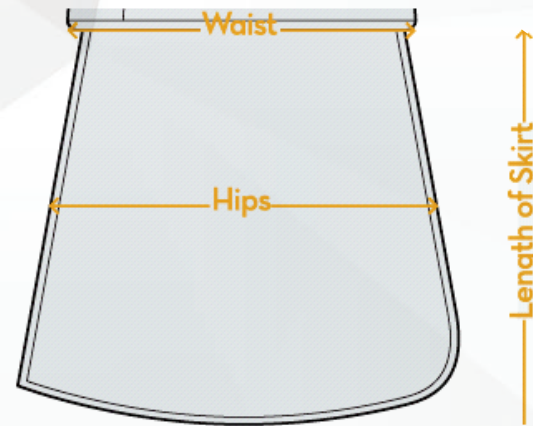

Step 1

Digit 1 & 2
Radiation Protection Apparel = X1

Step 2

Digit 3
Skirt = 3

Step 3

Digit 4
For Skirt: Optima = 2
Maxima = 2

Step 4

Digit 5
Ultralite = 1
Zerolead = 2
Leadlite = 3
Zerolead Air*

Step 5

Digit 6
0.25 mm Pb Front / 0.25 mm Pb back = 5
0.35 mm Pb Front / 0.25 mm Pb back = 6
0.50 mm Pb Front / 0.25 mm Pb back = 7
1.00 mm Pb Front / 0.25 mm Pb back = 8

Name

Department

Code



Step 6

(Digit 7)

Size	Width of Skirt	
	Girth of Operator	Our Size (Digit 7)
XS	80-85	G
S	86-91	S
M	92-97	O
L	98-107	R
XL	108-113	3
XXL	114-120	4
XXXL	121-127	N

Step 7

(Digit 8)

Length of Skirt
Our Length (Digit 8)
48 cm = A
53 cm = 2
57 cm = 3
62 cm = 4
65 cm = D
70 cm = E
75 cm = F

*ZeroLead Air variant is available in select geographies. Please get in touch with your Kiran representative for more details.

Coat Apron

We have 8 digits in Kiran Code

Step 1

Digit 1&2

Radiation Protection Apparel = X1

Step 2

Digit 3

Coat Apron = 1

Step 3

Digit 4

For Coat Apron: Basic = 0
 Coat Apron with back protection = 1
 Coat Apron with Front snaplock = 2
 Coat Apron with back snaplock = 3

Step 4

Digit 5

Ultralite = 1
 Zerolead = 2
 Leadlite = 3
 Zerolead Air*

Step 5

Digit 6

0.25 mm Pb Front = 1
 0.35 mm Pb Front = 2
 0.50 mm Pb Front = 3
 1.00 mm Pb Front = 4

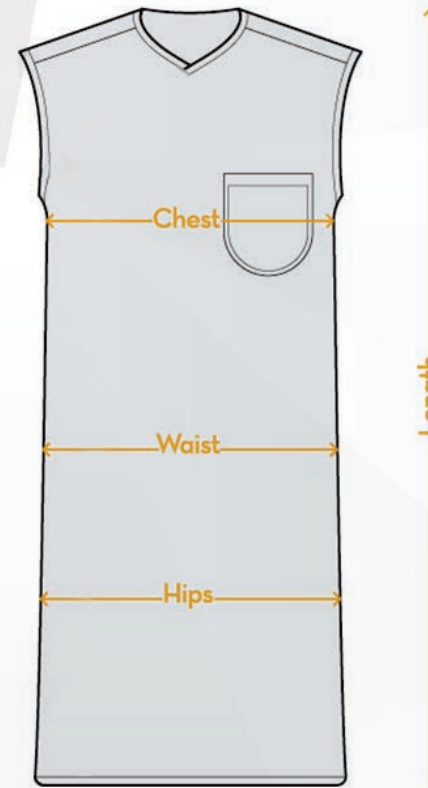

Name

Department

Code



Step 6

(Digit 7)

Size	Width of Coat Apron	
	Girth of Operator	Our Size (Digit 7)
XS	80-85	B
S	86-91	1
M	92-97	C
L	98-107	2
XL	108-113	3
XXL	114-120	E
XXXL	121-127	4

Step 7

(Digit 8)

Length of Coat Apron
Our Length (Digit 8)
85 cm = B
90 cm = 1
100 cm = 2
105 cm = D
110 cm = 3
115 cm = E
120 cm = 4

*ZeroLead Air variant is available in select geographies. Please get in touch with your Kiran representative for more details.

On A **Global Mission** With A **Local Heart**

Speaking your language across 180 countries



KIRAN^{*}
A Division of TRIVITRON Healthcare

www.kiranxray.com | www.trivitron.com
kiran@kiranxray.com

 /Trivitronindia

 /Trivitronindia

 /company/trivitron-healthcare

 /TrivitronHealthcare